

# Preliminary

# Water Quality Management Plan

For:

## Tippecanoe Industrial

APN(s): 0278-191-17, 0278-191-25, 0278-191-25, 0278-191-28, and 0278-191-12

### PA 21-20

Prepared for:

Oakmont Industrial Group

3520 Piedmont Road Suite 100

Atlanta, GA 30305

949-215-3796

Prepared by:

Huitt-Zollars, Inc.

3990 Concours, Suite 330

Ontario, CA 91764

(909) 941-7799

Prepared Date: 02/24/2022

Revision Date: TBD

Approval Date: \_\_\_\_\_

## Project Owner's Certification

This Water Quality Management Plan (WQMP) has been prepared for Oakmont Industrial Group by Huitt-Zollars, Inc. The WQMP is intended to comply with the requirements of the City of Highland and the NPDES Areawide Stormwater Program requiring the preparation of a WQMP. The undersigned, while it owns the subject property, is responsible for the implementation of the provisions of this plan and will ensure that this plan is amended as appropriate to reflect up-to-date conditions on the site consistent with San Bernardino County's Municipal Storm Water Management Program and the intent of the NPDES Permit for San Bernardino County and the incorporated cities of San Bernardino County within the Santa Ana Region. Once the undersigned transfers its interest in the property, its successors in interest and the city/county shall be notified of the transfer. The new owner will be informed of its responsibility under this WQMP. A copy of the approved WQMP shall be available on the subject site in perpetuity.

"I certify under a penalty of law that the provisions (implementation, operation, maintenance, and funding) of the WQMP have been accepted and that the plan will be transferred to future successors."

Project Data			
Permit/Application Number(s):	PA 21-20	Grading Permit Number(s):	TBD
Tract/Parcel Map Number(s):		Building Permit Number(s):	TBD
CUP, SUP, and/or APN (Specify Lot Numbers if Portions of Tract):			0278-191-17, 0278-191-25, 0278-191-25, 0278-191-28, and 0278-191-12
Owner's Signature			
<b>Owner Name: John Atwell</b>			
Title	Senior Vice President		
Company	Oakmont Industrial Group		
Address	3520 Piedmont Ave Suite 100 Atlanta, GA 30305		
Email	jatwell@oakmontre.com		
Telephone #	949-215-3796		
Signature		Date	

### Preparer's Certification

Project Data			
Permit/Application Number(s):	PA 21-20	Grading Permit Number(s):	TBD
Tract/Parcel Map Number(s):	TBD	Building Permit Number(s):	TBD
CUP, SUP, and/or APN (Specify Lot Numbers if Portions of Tract):			0278-191-17, 0278-191-25, 0278-191-25, 0278-191-28, and 0278-191-12

“The selection, sizing and design of stormwater treatment and other stormwater quality and quantity control measures in this plan were prepared under my oversight and meet the requirements of Regional Water Quality Control Board Order No. R8-2010-0036.”

<b>Engineer:</b> David White, PE		PE Stamp Below
Title	Vice President	
Company	Huitt-Zollars, Inc.	
Address	3990 Concours, Suite 330 Ontario, CA 91764	
Email	DWhite@Huitt-Zollars.com	
Telephone #	(909) 941-7799	
Signature		
Date		

# Table of Contents

<b>Section 1</b>	<b>Discretionary Permits .....</b>	<b>1-1</b>
<b>Section 2</b>	<b>Project Description .....</b>	<b>2-1</b>
	2.1 Project Information.....	2-1
	2.2 Property Ownership / Management .....	2-2
	2.3 Potential Stormwater Pollutants .....	2-3
	2.4 Water Quality Credits .....	2-4
<b>Section 3</b>	<b>Site and Watershed Description .....</b>	<b>3-1</b>
<b>Section 4</b>	<b>Best Management Practices .....</b>	<b>4-1</b>
	4.1 Source Control BMP .....	4-1
	4.1.1 Pollution Prevention .....	4-1
	4.1.2 Preventative LID Site Design Practices .....	4-6
	4.2 Project Performance Criteria.....	4-7
	4.3 Project Conformance Analysis.....	4-12
	4.3.1 Site Design Hydrologic Source Control BMP .....	4-14
	4.3.2 Infiltration BMP .....	4-16
	4.3.3 Harvest and Use BMP .....	4-18
	4.3.4 Biotreatment BMP.....	4-19
	4.3.5 Conformance Summary.....	4-23
	4.3.6 Hydromodification Control BMP .....	4-24
	4.4 Alternative Compliance Plan (if applicable) .....	4-25
<b>Section 5</b>	<b>Inspection &amp; Maintenance Responsibility Post Construction BMPs.....</b>	<b>5-1</b>
<b>Section 6</b>	<b>Site Plan and Drainage Plan.....</b>	<b>6-1</b>
	6.1. Site Plan and Drainage Plan.....	6-1
	6.2 Electronic Data Submittal .....	6-1

# Forms

<b>Form 1-1</b>	<b>Project Information .....</b>	<b>1-1</b>
<b>Form 2.1-1</b>	<b>Description of Proposed Project .....</b>	<b>2-1</b>
<b>Form 2.2-1</b>	<b>Property Ownership/Management .....</b>	<b>2-2</b>
<b>Form 2.3-1</b>	<b>Pollutants of Concern .....</b>	<b>2-3</b>
<b>Form 2.4-1</b>	<b>Water Quality Credits .....</b>	<b>2-4</b>
<b>Form 3-1</b>	<b>Site Location and Hydrologic Features .....</b>	<b>3-1</b>
<b>Form 3-2</b>	<b>Hydrologic Characteristics.....</b>	<b>3-2</b>
<b>Form 3-3</b>	<b>Watershed Description.....</b>	<b>3-3</b>
<b>Form 4.1-1</b>	<b>Non-Structural Source Control BMP .....</b>	<b>4-2</b>
<b>Form 4.1-2</b>	<b>Structural Source Control BMP .....</b>	<b>4-4</b>
<b>Form 4.1-3</b>	<b>Site Design Practices Checklist.....</b>	<b>4-6</b>
<b>Form 4.2-1</b>	<b>LID BMP Performance Criteria for Design Capture Volume .....</b>	<b>4-7</b>
<b>Form 4.2-2</b>	<b>Summary of HCOA Assessment.....</b>	<b>4-8</b>
<b>Form 4.2-3</b>	<b>HCOA Assessment for Runoff Volume .....</b>	<b>4-9</b>
<b>Form 4.2-4</b>	<b>HCOA Assessment for Time of Concentration .....</b>	<b>4-10</b>

Form 4.2-5 HCOC Assessment for Peak Runoff.....	4-11
Form 4.3-1 Infiltration BMP Feasibility .....	4-13
Form 4.3-2 Site Design Hydrologic Source Control BMP .....	4-14
Form 4.3-3 Infiltration LID BMP.....	4-17
Form 4.3-4 Harvest and Use BMP .....	4-18
Form 4.3-5 Selection and Evaluation of Biotreatment BMP .....	4-19
Form 4.3-6 Volume Based Biotreatment – Bioretention and Planter Boxes w/Underdrains	4-20
Form 4.3-7 Volume Based Biotreatment- Constructed Wetlands and Extended Detention	4-21
Form 4.3-8 Flow Based Biotreatment .....	4-22
Form 4.3-9 Conformance Summary and Alternative Compliance Volume Estimate .....	4-23
Form 4.3-10 Hydromodification Control BMP .....	4-24
Form 5-1 BMP Inspection and Maintenance .....	5-1

Attachment A: Vicinity Map & WQMP Site Plan

Attachment B: **Supporting Calc's, Rainfall Data & Manufacturer's Details**

Attachment C: Educational Materials

Attachment D: Infiltration Report & Worksheet H

Attachment E: Maintenance Agreement & Inspection Guidelines

## Section 1 Discretionary Permit(s)

<b>Form 1-1 Project Information</b>					
Project Name		Tippecanoe Industrial			
Project Owner Contact Name:		John Atwell			
Mailing Address:	3520 Piedmont Road Suite 100, Atlanta, GA 30305	E-mail Address:	jatwell@oakmontre.com	Telephone:	949-215-3796
Permit/Application Number(s):		PA 21-20	Tract/Parcel Map Number(s):	0278-191-17, 0278-191-25, 0278-191-25, 0278-191-28, and 0278-191-12	
Additional Information/Comments:		N/A			
Description of Project:		<p>The objective of this project is to build an industrial warehouse facility located on the southwest corner of 9<sup>th</sup> Street and Tippecanoe Avenue in San Bernardino, CA. The proposed warehouse is approximately 339,600 square feet in size on approximately 14.32 acres of undeveloped land. The site's runoff will be collected by catch basins and conveyed to the underground infiltration system. Stormwater runoff volume beyond the design capture volume (DCV) will be discharged into the existing storm drain lateral on the southwest corner of the project site.</p>			
Provide summary of Conceptual WQMP conditions (if previously submitted and approved). Attach complete copy.		N/A			

## Section 2 Project Description

### 2.1 Project Information

This section of the WQMP should provide the information listed below. The information provided for Conceptual/ Preliminary WQMP should give sufficient detail to identify the major proposed site design and LID BMPs and other anticipated water quality features that impact site planning. Final Project WQMP must specifically identify all BMP incorporated into the final site design and provide other detailed information as described herein.

The purpose of this information is to help determine the applicable development category, pollutants of concern, watershed description, and long term maintenance responsibilities for the project, and any applicable water quality credits. This information will be used in conjunction with the information in Section 3, Site Description, to establish the performance criteria and to select the LID BMP or other BMP for the project or other alternative programs that the project will participate in, which are described in Section 4.

<b>Form 2.1-1 Description of Proposed Project</b>					
<b>1</b> Development Category (Select all that apply):					
<input type="checkbox"/> Significant re-development involving the addition or replacement of 5,000 ft <sup>2</sup> or more of impervious surface on an already developed site	<input checked="" type="checkbox"/> New development involving the creation of 10,000 ft <sup>2</sup> or more of impervious surface collectively over entire site	<input type="checkbox"/> Automotive repair shops with standard industrial classification (SIC) codes 5013, 5014, 5541, 7532- 7534, 7536-7539	<input type="checkbox"/> Restaurants (with SIC code 5812) where the land area of development is 5,000 ft <sup>2</sup> or more		
<input type="checkbox"/> Hillside developments of 5,000 ft <sup>2</sup> or more which are located on areas with known erosive soil conditions or where the natural slope is 25 percent or more	<input type="checkbox"/> Developments of 2,500 ft <sup>2</sup> of impervious surface or more adjacent to (within 200 ft) or discharging directly into environmentally sensitive areas or waterbodies listed on the CWA Section 303(d) list of impaired waters.	<input checked="" type="checkbox"/> Parking lots of 5,000 ft <sup>2</sup> or more exposed to storm water	<input type="checkbox"/> Retail gasoline outlets that are either 5,000 ft <sup>2</sup> or more, or have a projected average daily traffic of 100 or more vehicles per day		
<input type="checkbox"/> Non-Priority / Non-Category Project <i>May require source control LID BMPs and other LIP requirements. Please consult with local jurisdiction on specific requirements.</i>					
<b>2</b> Project Area (ft <sup>2</sup> ):	623,832	<b>3</b> Number of Dwelling Units:	N/A	<b>4</b> SIC Code:	1541
<b>5</b> Is Project going to be phased? Yes <input type="checkbox"/> No <input checked="" type="checkbox"/> <i>If yes, ensure that the WQMP evaluates each phase as a distinct DA, requiring LID BMPs to address runoff at time of completion.</i>					
<b>6</b> Does Project include roads? Yes <input checked="" type="checkbox"/> No <input type="checkbox"/> <i>If yes, ensure that applicable requirements for transportation projects are addressed (see Appendix A of TGD for WQMP)</i>					

## 2.2 Property Ownership/Management

Describe the ownership/management of all portions of the project and site. State whether any infrastructure will transfer to public agencies (City, County, Caltrans, etc.) after project completion. State if a homeowners or property owners association will be formed and be responsible for the long-term maintenance of project stormwater facilities. Describe any lot-level stormwater features that will be the responsibility of individual property owners.

### Form 2.2-1 Property Ownership/Management

Describe property ownership/management responsible for long-term maintenance of WQMP stormwater facilities:

The property is being developed by Oakmont Industrial Group. Oakmont Industrial Group will be the entity responsible for long term maintenance of project stormwater facilities throughout the site.

Ownership/Management: Oakmont Industrial Group  
Address: 3520 Piedmont Road Suite 100, Atlanta, GA 30305  
Contact Person: John Atwell  
Phone: 949-215-3796  
Email: jatwell@oakmontre.com



## 2.3 Potential Stormwater Pollutants

Determine and describe expected stormwater pollutants of concern based on land uses and site activities (refer to Table 3-3 in the TGD for WQMP).

<b>Form 2.3-1 Pollutants of Concern</b>			
Pollutant	Please check: E=Expected, N=Not Expected		Additional Information and Comments
Pathogens (Bacterial / Virus)	E <input checked="" type="checkbox"/>	N <input type="checkbox"/>	Pathogens are typically caused by the transport of animal or human fecal wastes from the watershed.
Nutrients - Phosphorous	E <input checked="" type="checkbox"/>	N <input type="checkbox"/>	Primary sources of nutrients in urban runoff are fertilizers and eroded soils.
Nutrients - Nitrogen	E <input checked="" type="checkbox"/>	N <input type="checkbox"/>	Primary sources of nutrients in urban runoff are fertilizers and eroded soils.
Noxious Aquatic Plants	E <input checked="" type="checkbox"/>	N <input type="checkbox"/>	Noxious aquatic plants are typically from animals or vehicle transport that grow aggressively, multiply quickly without natural controls (native herbivores, soil chemistry, etc.), and adversely affect native habitats.
Sediment	E <input checked="" type="checkbox"/>	N <input type="checkbox"/>	Sediments are solid materials that are eroded from the land surface.
Metals	E <input checked="" type="checkbox"/>	N <input type="checkbox"/>	The primary source of metal pollution in stormwater is typically commercially available metals and metal products, as well as emissions from brake pad and tire tread wear associated with driving.
Oil and Grease	E <input checked="" type="checkbox"/>	N <input type="checkbox"/>	Primary sources of oil and grease are petroleum hydrocarbon products, motor products from leaking vehicles, esters, oils, fats, waxes, and high molecular-weight fatty acids.
Trash/Debris	E <input checked="" type="checkbox"/>	N <input type="checkbox"/>	Trash (such as paper, plastic, polystyrene packing foam, and aluminum materials) and biodegradable organic matter (such as leaves, grass cuttings, and food waste) are general waste from human or animals
Pesticides / Herbicides	E <input checked="" type="checkbox"/>	N <input type="checkbox"/>	Pesticides and herbicides can be washed off urban landscapes during storm events.
Organic Compounds	E <input checked="" type="checkbox"/>	N <input type="checkbox"/>	Sources of organic compounds may include waste handling areas and vehicle or landscape maintenance areas.
Other:	E <input type="checkbox"/>	N <input type="checkbox"/>	
Other:	E <input type="checkbox"/>	N <input type="checkbox"/>	
Other:	E <input type="checkbox"/>	N <input type="checkbox"/>	
Other:	E <input type="checkbox"/>	N <input type="checkbox"/>	

## 2.4 Water Quality Credits (N/A)

A water quality credit program is applicable for certain types of development projects if it is not feasible to meet the requirements for on-site LID. Proponents for eligible projects, as described below, can apply for water quality credits that would reduce project obligations for selecting and sizing other treatment BMP or participating in other alternative compliance programs. Refer to Section 6.2 in the TGD for WQMP to determine if water quality credits are applicable for the project.

<b>Form 2.4-1 Water Quality Credits</b>			
<b>1</b> Project Types that Qualify for Water Quality Credits: <i>Select all that apply</i>			
<input type="checkbox"/> Redevelopment projects that reduce the overall impervious footprint of the project site. [Credit = % impervious reduced]	Higher density development projects <input type="checkbox"/> Vertical density [20%] <input type="checkbox"/> 7 units/ acre [5%]	<input type="checkbox"/> Mixed use development, (combination of residential, commercial, industrial, office, institutional, or other land uses which incorporate design principles that demonstrate environmental benefits not realized through single use projects) [20%]	<input type="checkbox"/> Brownfield redevelopment (redevelop real property complicated by presence or potential of hazardous contaminants) [25%]
<input type="checkbox"/> Redevelopment projects in established historic district, historic preservation area, or similar significant core city center areas [10%]	<input type="checkbox"/> Transit-oriented developments (mixed use residential or commercial area designed to maximize access to public transportation) [20%]	<input type="checkbox"/> In-fill projects (conversion of empty lots & other underused spaces < 5 acres, substantially surrounded by urban land uses, into more beneficially used spaces, such as residential or commercial areas) [10%]	<input type="checkbox"/> Live-Work developments (variety of developments designed to support residential and vocational needs) [20%]
<b>2</b> Total Credit % 0 <i>(Total all credit percentages up to a maximum allowable credit of 50 percent)</i>			
Description of Water Quality Credit Eligibility (if applicable)	N/A		

## Section 3 Site and Watershed Description

Describe the project site conditions that will facilitate the selection of BMP through an analysis of the physical conditions and limitations of the site and its receiving waters. Identify distinct drainage areas (DA) that collect flow from a portion of the site and describe how runoff from each DA (and sub-watershed DMAs) is conveyed to the site outlet(s). Refer to Section 3.2 in the TGD for WQMP. The form below is provided as an example.

Then complete Forms 3.2 and 3.3 for each DA on the project site. ***If the project has more than one drainage area for stormwater management, then complete additional versions of these forms for each DA / outlet.***

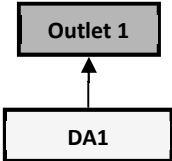
Form 3-1 Site Location and Hydrologic Features			
Site coordinates take GPS measurement at approximate center of site	Latitude 34° 6'51.51"N	Longitude 117°15'43.72"W	Thomas Bros Map page 577
<p><sup>1</sup> San Bernardino County climatic region: <input checked="" type="checkbox"/> Valley <input type="checkbox"/> Mountain</p>			
<p><sup>2</sup> Does the site have more than one drainage area (DA): Yes <input type="checkbox"/> No <input checked="" type="checkbox"/> <i>If no, proceed to Form 3-2. If yes, then use this form to show a conceptual schematic describing DMAs and hydrologic feature connecting DMAs to the site outlet(s). An example is provided below that can be modified for proposed project or a drawing clearly showing DMA and flow routing may be attached</i></p>			
			
Conveyance	Briefly describe on-site drainage features to convey runoff that is not retained within a DMA		
DA1 DMA A to Outlet 1	Runoff from the area DA1 will be directed to the proposed underground infiltration system on the southwest corner of the site. Underground infiltration system overflow will be conveyed by the 36-inch outlet pipe and discharge into the existing storm drain lateral on the southwest corner of property.		
DA1 DMA B to Outlet 1	N/A		
DA2 to Outlet 2	N/A		

<b>Form 3-2 Existing Hydrologic Characteristics for Drainage Area 1</b>				
For Drainage Area 1's sub-watershed DMA, provide the following characteristics	DMA A	DMA B	DMA C	DMA D
<b>1</b> DMA drainage area (ft <sup>2</sup> )	623,832	N/A	N/A	N/A
<b>2</b> Existing site impervious area (ft <sup>2</sup> )	566,699	N/A	N/A	N/A
<b>3</b> Antecedent moisture condition <i>For desert areas, use <a href="http://www.sbcounty.gov/dpw/floodcontrol/pdf/20100412_map.pdf">http://www.sbcounty.gov/dpw/floodcontrol/pdf/20100412_map.pdf</a></i>	AMC II	N/A	N/A	N/A
<b>4</b> Hydrologic soil group <i>Refer to Watershed Mapping Tool – <a href="http://permitrack.sbcounty.gov/wap/">http://permitrack.sbcounty.gov/wap/</a></i>	B	N/A	N/A	N/A
<b>5</b> Longest flowpath length (ft)	979	N/A	N/A	N/A
<b>6</b> Longest flowpath slope (ft/ft)	0.008	N/A	N/A	N/A
<b>7</b> Current land cover type(s) <i>Select from Fig C-3 of Hydrology Manual</i>	Annual Grass	N/A	N/A	N/A
<b>8</b> Pre-developed pervious area condition: <i>Based on the extent of wet season vegetated cover good &gt;75%; Fair 50-75%; Poor &lt;50% Attach photos of site to support rating</i>	Poor	N/A	N/A	N/A

<b>Form 3-2 Existing Hydrologic Characteristics for Drainage Area 1 (use only as needed for additional DMA w/in DA 1)</b>				
For Drainage Area 1's sub-watershed DMA, provide the following characteristics	DMA E	DMA F	DMA G	DMA H
<b>1</b> DMA drainage area (ft <sup>2</sup> )	N/A	N/A	N/A	N/A
<b>2</b> Existing site impervious area (ft <sup>2</sup> )	N/A	N/A	N/A	N/A
<b>3</b> Antecedent moisture condition <i>For desert areas, use <a href="http://www.sbcounty.gov/dpw/floodcontrol/pdf/20100412_map.pdf">http://www.sbcounty.gov/dpw/floodcontrol/pdf/20100412_map.pdf</a></i>	N/A	N/A	N/A	N/A
<b>4</b> Hydrologic soil group <i>Refer to Watershed Mapping Tool – <a href="http://permitrack.sbcounty.gov/wap/">http://permitrack.sbcounty.gov/wap/</a></i>	N/A	N/A	N/A	N/A
<b>5</b> Longest flowpath length (ft)	N/A	N/A	N/A	N/A
<b>6</b> Longest flowpath slope (ft/ft)	N/A	N/A	N/A	N/A
<b>7</b> Current land cover type(s) <i>Select from Fig C-3 of Hydrology Manual</i>	N/A	N/A	N/A	N/A
<b>8</b> Pre-developed pervious area condition: <i>Based on the extent of wet season vegetated cover good &gt;75%; Fair 50-75%; Poor &lt;50% Attach photos of site to support rating</i>	N/A	N/A	N/A	N/A

<b>Form 3-3 Watershed Description for Drainage Area</b>	
<p>Receiving waters  <i>Refer to Watershed Mapping Tool - <a href="http://permitrack.sbcounty.gov/wap/">http://permitrack.sbcounty.gov/wap/</a></i>  <i>See "Drainage Facilities" link at this website</i></p>	<p>6<sup>th</sup> Street Storm Drain; Twin Creek Channel; Warm Creek Channel; Santa Ana Reach 5,4,3, 2, and 1; Prado Control basin; and Pacific Ocean.</p>
<p>Applicable TMDLs  <i>Refer to Local Implementation Plan</i></p>	<p>Santa Ana River Reach 3: Copper, Lead, and Pathogens</p>
<p>303(d) listed impairments  <i>Refer to Local Implementation Plan and Watershed Mapping Tool - <a href="http://permitrack.sbcounty.gov/wap/">http://permitrack.sbcounty.gov/wap/</a> and State Water Resources Control Board website - <a href="http://www.waterboards.ca.gov/santaana/water_issues/programs/tmdl/index.shtml">http://www.waterboards.ca.gov/santaana/water_issues/programs/tmdl/index.shtml</a></i></p>	<p>Santa Ana Reach2: bacteria indicator.                      Santa Ana Reach 3: copper, lead, pathogens.                      Santa Ana Reach 4: pathogens.                      Prado Control Basin: nutrients, pathogens, TSS.</p>
<p>Environmentally Sensitive Areas (ESA)  <i>Refer to Watershed Mapping Tool - <a href="http://permitrack.sbcounty.gov/wap/">http://permitrack.sbcounty.gov/wap/</a></i></p>	<p>None</p>
<p>Unlined Downstream Water Bodies  <i>Refer to Watershed Mapping Tool - <a href="http://permitrack.sbcounty.gov/wap/">http://permitrack.sbcounty.gov/wap/</a></i></p>	<p>Santa Ana River</p>
<p>Hydrologic Conditions of Concern</p>	<p><input type="checkbox"/> Yes <i>Complete Hydrologic Conditions of Concern (HCO) Assessment. Include Forms 4.2-2 through Form 4.2-5 and Hydromodification BMP Form 4.3-10 in submittal</i>  <input checked="" type="checkbox"/> No</p>
<p>Watershed-based BMP included in a RWQCB approved WAP</p>	<p><input type="checkbox"/> Yes <i>Attach verification of regional BMP evaluation criteria in WAP</i></p> <ul style="list-style-type: none"> <li>• <i>More Effective than On-site LID</i></li> <li>• <i>Remaining Capacity for Project DCV</i></li> <li>• <i>Upstream of any Water of the US</i></li> <li>• <i>Operational at Project Completion</i></li> <li>• <i>Long-Term Maintenance Plan</i></li> </ul> <p><input checked="" type="checkbox"/> No</p>

## Section 4 Best Management Practices (BMP)

### 4.1 Source Control BMP

#### 4.1.1 Pollution Prevention

Non-structural and structural source control BMP are required to be incorporated into all new development and significant redevelopment projects. Form 4.1-1 and 4.1-2 are used to describe specific source control BMPs used in the WQMP or to explain why a certain BMP is not applicable. Table 7-3 of the TGD for WQMP provides a list of applicable source control BMP for projects with specific types of potential pollutant sources or activities. The source control BMP in this table must be implemented for projects with these specific types of potential pollutant sources or activities.

The preparers of this WQMP have reviewed the source control BMP requirements for new development and significant redevelopment projects. The preparers have also reviewed the specific BMP required for project as specified in Forms 4.1-1 and 4.1-2. All applicable non-structural and structural source control BMP shall be implemented in the project.

**Form 4.1.1-1 Non-Structural Source Control BMPs**

Identifier	Name	Check One		Describe BMP Implementation OR, if not applicable, state reason
		Included	Not Applicable	
N1	Education of Property Owners, Tenants and Occupants on Stormwater BMPs	<input checked="" type="checkbox"/>	<input type="checkbox"/>	Property owners shall review and become familiar with the site specific WQMP. Additional educational materials for day to day operations are contained in Attachment C. Additional materials can be obtained from the local water pollution prevention program. Education of property owners begin with the review/preparation of the site specific WQMP and continues through the review of additional educational material as it applies to the project.
N2	Activity Restrictions	<input checked="" type="checkbox"/>	<input type="checkbox"/>	Activity restriction shall be stated in the owners lease terms prior to occupancy: <ul style="list-style-type: none"> <li>Fuelling areas, air/water supply areas, maintenance bays, vehicle washing areas, outdoor material storage areas, outdoor work areas, outdoor processing areas, wash water from food preparation areas within the project site will not be allowed on the project site.</li> <li>Storage of hazardous materials will not be allowed on the project site.</li> <li>All pesticide applications shall be performed by a licensed contractor certified by the California Department of Pesticide Regulation.</li> <li>All dumpster lids shall be kept closed at all times.</li> <li>Blowing, sweeping or hosing of debris (leaf, litter, grass clippings, trash or debris) into the streets, underground stormdrain facilities or other storm water conveyance areas shall be strictly prohibited</li> </ul>
N3	Landscape Management BMPs	<input checked="" type="checkbox"/>	<input type="checkbox"/>	A landscape architect will provide design plans for the on-site landscaping and irrigation system. The design shall incorporate the use of native and drought tolerant trees and shrubs throughout the project site.
N4	BMP Maintenance	<input checked="" type="checkbox"/>	<input type="checkbox"/>	Property owners shall maintain the designated on-site BMP areas, see Section 5 for self inspection and maintenance form
N5	Title 22 CCR Compliance (How development will comply)	<input type="checkbox"/>	<input checked="" type="checkbox"/>	Title 22 CCR does not apply to the proposed development: industrial warehouses.



**Form 4.1-1 Non-Structural Source Control BMPs**

N6	Local Water Quality Ordinances	<input checked="" type="checkbox"/>	<input type="checkbox"/>	Local Water Quality Ordinances will be addressed by implementation of stormwater BMPs: catch basin filters, hydrodynamic separators, and underground infiltration system.
N7	Spill Contingency Plan	<input checked="" type="checkbox"/>	<input type="checkbox"/>	Industrial Warehouse buildings and truck dock areas have potential for spills and therefore each tenant shall be required to prepare a spill contingency plan and it shall be implemented in accordance with section 6.95 of the California Health and Safety Code. The spill contingency plan shall identify responsible personnel in the event of a spill, an action item list identifying how the spill should be contained and cleaned up, and who should be contacted in the event of a spill. Documentation of any spill event and cleanup process shall be kept on site in perpetuity.
N8	Underground Storage Tank Compliance	<input type="checkbox"/>	<input checked="" type="checkbox"/>	No underground storage tanks are proposed for this site.
N9	Hazardous Materials Disclosure Compliance	<input type="checkbox"/>	<input checked="" type="checkbox"/>	No hazardous materials are planned to be stored or used at this site.

**Form 4.1-1 Non-Structural Source Control BMPs**

Identifier	Name	Check One		Describe BMP Implementation OR, if not applicable, state reason
		Included	Not Applicable	
N10	Uniform Fire Code Implementation	<input checked="" type="checkbox"/>	<input type="checkbox"/>	Underground fire protection service and fire sprinklers will be provided per the uniform fire code and the requirements of the County of San Bernardino Fire Department.
N11	Litter/Debris Control Program	<input checked="" type="checkbox"/>	<input type="checkbox"/>	Trash storage areas will be designed to have adjacent areas drain away from the trash storage areas. The trash storage areas shall be inspected and maintained on a monthly basis. Collection of trash from the trash storage areas shall occur on a regular basis to ensure that the trash receptacles are not overflowing. Documentation of such inspection/maintenance and trash collection shall be kept by the owner in perpetuity. See the WQMP site map in Attachment A for anticipated location of trash storage areas.
N12	Employee Training	<input checked="" type="checkbox"/>	<input type="checkbox"/>	The following requirements shall be stated in the owners lease terms; an Employee Training/Education program shall be provided annually to help educate employees about storm water quality management and practices that help prevent storm water pollution. Documentation of such training/education program implementation shall be kept by the owner for a minimum of ten years. Sample education materials have been provided in Attachment C. Additional educational materials can be obtained from the City of Fontana or the County of San Bernardino storm water program.
N13	Housekeeping of Loading Docks	<input checked="" type="checkbox"/>	<input type="checkbox"/>	The development will have loading docks. The loading docks shall be inspected on a weekly basis to help ensure that any trash and debris are collected prior to being washed into the underground storm drain system. All stormwater runoff from the loading dock areas will be collected by the underground infiltration system prior to conveyance to the public storm drain system. Documentation of such inspection/maintenance shall be kept by the owner in perpetuity.
N14	Catch Basin Inspection Program	<input checked="" type="checkbox"/>	<input type="checkbox"/>	The onsite catch basins shall be inspected on a quarterly basis. Inspection of the on-site catch basins shall consist of visual inspection of any sediment, trash or debris collected in the bottom of each catch basin. Any sediment, trash or debris found shall be removed from the catch basins and disposed of in a legal manner. Documentation of such inspection/maintenance shall be kept by the owner in perpetuity.

**Water Quality Management Plan (WQMP)**

N15	Vacuum Sweeping of Private Streets and Parking Lots	<input checked="" type="checkbox"/>	<input type="checkbox"/>	The on-site parking lots, drive aisles, and loading dock areas shall be swept on a monthly basis. Documentation of such sweeping shall be kept by the owner in perpetuity. Frequency of sweeping shall be adjusted as needed to maintain a clean site.
N16	Other Non-structural Measures for Public Agency Projects	<input type="checkbox"/>	<input checked="" type="checkbox"/>	Not Applicable
N17	Comply with all other applicable NPDES permits	<input checked="" type="checkbox"/>	<input type="checkbox"/>	General construction permit "SWRCB Orders No. 2009-009-DWQ as amended by Order 2010-0014-DWQ"

**Form 4.1-2 Structural Source Control BMPs**

Identifier	Name	Check One		Describe BMP Implementation OR, if not applicable, state reason
		Included	Not Applicable	
S1	Provide storm drain system stenciling and signage (CASQA New Development BMP Handbook SD-13)	<input checked="" type="checkbox"/>	<input type="checkbox"/>	The on-site storm drain catch basins shall be stenciled with the phrase "Drains to River" or other approved language. The signage shall be inspected on an annual basis. Missing or faded signage shall be replaced. Documentation of such inspection/maintenance shall be kept by the owner in perpetuity.
S2	Design and construct outdoor material storage areas to reduce pollution introduction (CASQA New Development BMP Handbook SD-34)	<input type="checkbox"/>	<input checked="" type="checkbox"/>	No outdoor material storage areas are proposed for this site.
S3	Design and construct trash and waste storage areas to reduce pollution introduction (CASQA New Development BMP Handbook SD-32)	<input checked="" type="checkbox"/>	<input type="checkbox"/>	Trash storage areas will be designed to have adjacent areas drain away from the trash storage areas as well as have a permanent roof over them. The trash storage areas shall be inspected and maintained on a monthly basis. Collection of trash from the trash storage areas shall occur on a regular basis to ensure that the trash receptacles are not overflowing. Documentation of such inspection/maintenance and trash collection shall be kept by the owner in perpetuity. See the WQMP site map in Attachment A for anticipated location of trash storage areas.
S4	Use efficient irrigation systems & landscape design, water conservation, smart controllers, and source control (Statewide Model Landscape Ordinance; CASQA New Development BMP Handbook SD-12)	<input checked="" type="checkbox"/>	<input type="checkbox"/>	The landscape architect will provide design plans for the on-site irrigation system. The irrigation system shall be inspected on a monthly basis to ensure proper operation. Any broken sprinkler heads shall be repaired immediately to ensure that the system continues to operate efficiently. Documentation of such inspection/maintenance shall be kept by the owner in perpetuity.
S5	Finish grade of landscaped areas at a minimum of 1-2 inches below top of curb, sidewalk, or pavement	<input checked="" type="checkbox"/>	<input type="checkbox"/>	The landscape architect will provide design plans for the on-site landscaping and irrigation system. The design shall incorporate a finish grade of landscaped areas at a minimum of 1-2 inches below top of curb, sidewalk, or pavement throughout the project site.
S6	Protect slopes and channels and provide energy dissipation (CASQA New Development BMP Handbook SD-10)	<input type="checkbox"/>	<input checked="" type="checkbox"/>	No designed slope and channel are planned for this site.
S7	Covered dock areas (CASQA New Development BMP Handbook SD-31)	<input type="checkbox"/>	<input checked="" type="checkbox"/>	No covered dock areas are planned for this site.

### Form 4.1-2 Structural Source Control BMPs

Identifier	Name	Check One		Describe BMP Implementation OR, If not applicable, state reason
		Included	Not Applicable	
S8	Covered maintenance bays with spill containment plans (CASQA New Development BMP Handbook SD-31)	<input type="checkbox"/>	<input checked="" type="checkbox"/>	No maintenance bays are planned for this site.
S9	Vehicle wash areas with spill containment plans (CASQA New Development BMP Handbook SD-33)	<input type="checkbox"/>	<input checked="" type="checkbox"/>	No vehicle wash areas are planned for this site.
S10	Covered outdoor processing areas (CASQA New Development BMP Handbook SD-36)	<input type="checkbox"/>	<input checked="" type="checkbox"/>	No outdoor processing areas are planned for this site.
S11	Equipment wash areas with spill containment plans (CASQA New Development BMP Handbook SD-33)	<input type="checkbox"/>	<input checked="" type="checkbox"/>	No equipment wash areas are planned for this site.
S12	Fueling areas (CASQA New Development BMP Handbook SD-30)	<input type="checkbox"/>	<input checked="" type="checkbox"/>	No fueling planned for this site.
S13	Hillside landscaping (CASQA New Development BMP Handbook SD-10)	<input type="checkbox"/>	<input checked="" type="checkbox"/>	No hillside landscaping planned in this area.
S14	Wash water control for food preparation areas	<input type="checkbox"/>	<input checked="" type="checkbox"/>	Food preparation is not planned for this site.
S15	Community car wash racks (CASQA New Development BMP Handbook SD-33)	<input type="checkbox"/>	<input checked="" type="checkbox"/>	No community car wash racks are planned for this site.

### 4.1.2 Preventative LID Site Design Practices

Site design practices associated with new LID requirements in the MS4 Permit should be considered in the earliest phases of a project. Preventative site design practices can result in smaller DCV for LID BMP and hydromodification control BMP by reducing runoff generation. Describe site design and drainage plan including:

- A narrative of site design practices utilized or rationale for not using practices
- A narrative of how site plan incorporates preventive site design practices
- Include an attached Site Plan layout which shows how preventative site design practices are included in WQMP

Refer to Section 5.2 of the TGD for WQMP for more details.

<b>Form 4.1-3 Preventative LID Site Design Practices Checklist</b>
<p>Site Design Practices <i>If yes, explain how preventative site design practice is addressed in project site plan. If no, other LID BMPs must be selected to meet targets</i></p>
<p>Minimize impervious areas: Yes <input type="checkbox"/> No <input checked="" type="checkbox"/></p> <p>Explanation: The developer has chosen to maximize the building and parking footprint. An underground infiltration system is sized accordingly to mitigate peak stormwater runoff from the proposed development.</p>
<p>Maximize natural infiltration capacity: Yes <input checked="" type="checkbox"/> No <input type="checkbox"/></p> <p>Explanation: The entire development is designed to drain to the underground infiltration system thereby maximizing the natural infiltration capacity.</p>
<p>Preserve existing drainage patterns and time of concentration: Yes <input checked="" type="checkbox"/> No <input type="checkbox"/></p> <p>Explanation: The development will preserve the existing southwesterly drainage pattern. Post-development runoff will drain to an on-site underground infiltration system. The proposed storm drain and underground infiltration system will lengthen the time of concentration thus mimicing the existing conditions.</p>
<p>Disconnect impervious areas: Yes <input type="checkbox"/> No <input checked="" type="checkbox"/></p> <p>Explanation: All impervious areas are designed to direct runoff to the catch basins, hydrodynamic separators, and underground infiltration system.</p>
<p>Protect existing vegetation and sensitive areas: Yes <input type="checkbox"/> No <input checked="" type="checkbox"/></p> <p>Explanation: The site has no existing vegetation or sensitive areas to protect. Planting of new vegetation will occur throughout the site.</p>
<p>Re-vegetate disturbed areas: Yes <input checked="" type="checkbox"/> No <input type="checkbox"/></p> <p>Explanation: All landscape areas will be vegetated for stabilization. Landscape areas may also provide an area for stormwater infiltration.</p>
<p>Minimize unnecessary compaction in stormwater retention/infiltration basin/trench areas: Yes <input checked="" type="checkbox"/> No <input type="checkbox"/></p> <p>Explanation: Compaction of the soils in the proposed infiltration system's footprint will be minimized during construction.</p>
<p>Utilize vegetated drainage swales in place of underground piping or imperviously lined swales: Yes <input type="checkbox"/> No <input checked="" type="checkbox"/></p> <p>Explanation: The proposed site plan does not allow vegetated drainage swales to be incorporated into drainage facilities. Runoff will be routed to on-site hydrodynamic separators and an underground infiltration system.</p>

## 4.2 Project Performance Criteria

The purpose of this section of the Project WQMP is to establish targets for post-development hydrology based on performance criteria specified in the MS4 Permit. These targets include runoff volume for water quality control (referred to as LID design capture volume), and runoff volume, time of concentration, and peak runoff for protection of any downstream waterbody segments with a HCOC. ***If the project has more than one outlet for stormwater runoff, then complete additional versions of these forms for each DA / outlet.***

Methods applied in the following forms include:

- For LID BMP Design Capture Volume (DCV), the San Bernardino County Stormwater Program requires use of the P<sub>6</sub> method (MS4 Permit Section XI.D.6a.ii) – Form 4.2-1
- For HCOC pre- and post-development hydrologic calculation, the San Bernardino County Stormwater Program requires the use of the Rational Method (San Bernardino County Hydrology Manual Section D). Forms 4.2-2 through Form 4.2-5 calculate hydrologic variables including runoff volume, time of concentration, and peak runoff from the project site pre- and post-development using the Hydrology Manual Rational Method approach. For projects greater than 640 acres (1.0 mi<sup>2</sup>), the Rational Method and these forms should not be used. For such projects, the Unit Hydrograph Method (San Bernardino County Hydrology Manual Section E) shall be applied for hydrologic calculations for HCOC performance criteria.

Refer to Section 4 in the TGD for WQMP for detailed guidance and instructions.

<b>Form 4.2-1 LID BMP Performance Criteria for Design Capture Volume (DA 1)</b>		
<b>1</b> Project area DA 1 (ft <sup>2</sup> ): 623,832	<b>2</b> Imperviousness after applying preventative site design practices (Imp%): 0.9	<b>3</b> Runoff Coefficient (Rc): 0.73 $R_c = 0.858(\text{Imp}\%)^{0.3} - 0.78(\text{Imp}\%)^{0.2} + 0.774(\text{Imp}\%) + 0.04$
<b>4</b> Determine 1-hour rainfall depth for a 2-year return period P <sub>2yr-1hr</sub> (in): 0.546 <a href="http://hdsc.nws.noaa.gov/hdsc/pfds/sa/sca_pfds.html">http://hdsc.nws.noaa.gov/hdsc/pfds/sa/sca_pfds.html</a>		
<b>5</b> Compute P <sub>6</sub> , Mean 6-hr Precipitation (inches): 0.808 <i>P<sub>6</sub> = Item 4 * C<sub>1</sub>, where C<sub>1</sub> is a function of site climatic region specified in Form 3-1 Item 1 (Valley = 1.4807; Mountain = 1.909; Desert = 1.2371)</i>		
<b>6</b> Drawdown Rate <i>Use 48 hours as the default condition. Selection and use of the 24 hour drawdown time condition is subject to approval by the local jurisdiction. The necessary BMP footprint is a function of drawdown time. While shorter drawdown times reduce the performance criteria for LID BMP design capture volume, the depth of water that can be stored is also reduced.</i>		24-hrs <input type="checkbox"/> 48-hrs <input checked="" type="checkbox"/>
<b>7</b> Compute design capture volume, DCV (ft <sup>3</sup> ): 60,192 $DCV = 1/12 * [\text{Item 1} * \text{Item 3} * \text{Item 5} * C_2]$ , where C <sub>2</sub> is a function of drawdown rate (24-hr = 1.582; 48-hr = 1.963) <i>Compute separate DCV for each outlet from the project site per schematic drawn in Form 3-1 Item 2</i>		

## Form 4.2-2 Summary of HCOC Assessment (DA 1)

Does project have the potential to cause or contribute to an HCOC in a downstream channel: Yes  No

Go to: <http://permitrack.sbcounty.gov/wap/>

If "Yes", then complete HCOC assessment of site hydrology for 2yr storm event using Forms 4.2-3 through 4.2-5 and insert results below  
(Forms 4.2-3 through 4.2-5 may be replaced by computer software analysis based on the San Bernardino County Hydrology Manual)

If "No," then proceed to Section 4.3 Project Conformance Analysis

Condition	Runoff Volume (ft <sup>3</sup> )	Time of Concentration (min)	Peak Runoff (cfs)
Pre-developed	<b>1</b> N/A <i>Form 4.2-3 Item 12</i>	<b>2</b> N/A <i>Form 4.2-4 Item 13</i>	<b>3</b> N/A <i>Form 4.2-5 Item 10</i>
Post-developed	<b>4</b> N/A <i>Form 4.2-3 Item 13</i>	<b>5</b> N/A <i>Form 4.2-4 Item 14</i>	<b>6</b> N/A <i>Form 4.2-5 Item 14</i>
Difference	<b>7</b> N/A <i>Item 4 – Item 1</i>	<b>8</b> N/A <i>Item 2 – Item 5</i>	<b>9</b> N/A <i>Item 6 – Item 3</i>
Difference (as % of pre-developed)	<b>10</b> N/A <i>Item 7 / Item 1</i>	<b>11</b> N/A <i>Item 8 / Item 2</i>	<b>12</b> N/A <i>Item 9 / Item 3</i>



**Form 4.2-3 HCOC Assessment for Runoff Volume (DA 1)**

<b>Weighted Curve Number Determination for: Pre-developed DA</b>	DMA A	DMA B	DMA C	DMA D	DMA E	DMA F	DMA G	DMA H
<b>1a</b> Land Cover type	N/A	N/A	N/A	N/A	N/A	N/A	N/A	N/A
<b>2a</b> Hydrologic Soil Group (HSG)	N/A	N/A	N/A	N/A	N/A	N/A	N/A	N/A
<b>3a</b> DMA Area, ft <sup>2</sup> sum of areas of DMA should equal area of DA	N/A	N/A	N/A	N/A	N/A	N/A	N/A	N/A
<b>4a</b> Curve Number (CN) use Items 1 and 2 to select the appropriate CN from Appendix C-2 of the TGD for WQMP	N/A	N/A	N/A	N/A	N/A	N/A	N/A	N/A
<b>Weighted Curve Number Determination for: Post-developed DA</b>	DMA A	DMA B	DMA C	DMA D	DMA E	DMA F	DMA G	DMA H
<b>1b</b> Land Cover type	N/A	N/A	N/A	N/A	N/A	N/A	N/A	N/A
<b>2b</b> Hydrologic Soil Group (HSG)	N/A	N/A	N/A	N/A	N/A	N/A	N/A	N/A
<b>3b</b> DMA Area, ft <sup>2</sup> sum of areas of DMA should equal area of DA	N/A	N/A	N/A	N/A	N/A	N/A	N/A	N/A
<b>4b</b> Curve Number (CN) use Items 5 and 6 to select the appropriate CN from Appendix C-2 of the TGD for WQMP	N/A	N/A	N/A	N/A	N/A	N/A	N/A	N/A
<b>5</b> Pre-Developed area-weighted CN: N/A	<b>7</b> Pre-developed soil storage capacity, S (in): N/A $S = (1000 / \text{Item } 5) - 10$				<b>9</b> Initial abstraction, I <sub>a</sub> (in): N/A $I_a = 0.2 * \text{Item } 7$			
<b>6</b> Post-Developed area-weighted CN: N/A	<b>8</b> Post-developed soil storage capacity, S (in): N/A $S = (1000 / \text{Item } 6) - 10$				<b>10</b> Initial abstraction, I <sub>a</sub> (in): N/A $I_a = 0.2 * \text{Item } 8$			
<b>11</b> Precipitation for 2 yr, 24 hr storm (in): N/A Go to: <a href="http://hdsc.nws.noaa.gov/hdsc/pfds/so/sca_pfds.html">http://hdsc.nws.noaa.gov/hdsc/pfds/so/sca_pfds.html</a>								
<b>12</b> Pre-developed Volume (ft <sup>3</sup> ): N/A $V_{pre} = (1 / 12) * (\text{Item sum of Item } 3) * [(\text{Item } 11 - \text{Item } 9)^2 / ((\text{Item } 11 - \text{Item } 9 + \text{Item } 7))$								
<b>13</b> Post-developed Volume (ft <sup>3</sup> ): N/A $V_{pre} = (1 / 12) * (\text{Item sum of Item } 3) * [(\text{Item } 11 - \text{Item } 10)^2 / ((\text{Item } 11 - \text{Item } 10 + \text{Item } 8))$								
<b>14</b> Volume Reduction needed to meet HCOC Requirement, (ft <sup>3</sup> ): N/A $V_{HCOC} = (\text{Item } 13 * 0.95) - \text{Item } 12$								

### Form 4.2-4 HCOC Assessment for Time of Concentration (DA 1)

Compute time of concentration for pre and post developed conditions for each DA (For projects using the Hydrology Manual complete the form below)

Variables	Pre-developed DA1 <i>Use additional forms if there are more than 4 DMA</i>				Post-developed DA1 <i>Use additional forms if there are more than 4 DMA</i>			
	DMA A	DMA B	DMA C	DMA D	DMA A	DMA B	DMA C	DMA D
<b>1</b> Length of flowpath (ft) <i>Use Form 3-2 Item 5 for pre-developed condition</i>	N/A	N/A	N/A	N/A	N/A	N/A	N/A	N/A
<b>2</b> Change in elevation (ft)	N/A	N/A	N/A	N/A	N/A	N/A	N/A	N/A
<b>3</b> Slope (ft/ft), $S_o = \text{Item 2} / \text{Item 1}$	N/A	N/A	N/A	N/A	N/A	N/A	N/A	N/A
<b>4</b> Land cover	N/A	N/A	N/A	N/A	N/A	N/A	N/A	N/A
<b>5</b> Initial DMA Time of Concentration (min) <i>Appendix C-1 of the TGD for WQMP</i>	N/A	N/A	N/A	N/A	N/A	N/A	N/A	N/A
<b>6</b> Length of conveyance from DMA outlet to project site outlet (ft) <i>May be zero if DMA outlet is at project site outlet</i>	N/A	N/A	N/A	N/A	N/A	N/A	N/A	N/A
<b>7</b> Cross-sectional area of channel (ft <sup>2</sup> )	N/A	N/A	N/A	N/A	N/A	N/A	N/A	N/A
<b>8</b> Wetted perimeter of channel (ft)	N/A	N/A	N/A	N/A	N/A	N/A	N/A	N/A
<b>9</b> Manning's roughness of channel (n)	N/A	N/A	N/A	N/A	N/A	N/A	N/A	N/A
<b>10</b> Channel flow velocity (ft/sec) $V_{fps} = (1.49 / \text{Item 9}) * (\text{Item 7} / \text{Item 8})^{0.67} * (\text{Item 3})^{0.5}$	N/A	N/A	N/A	N/A	N/A	N/A	N/A	N/A
<b>11</b> Travel time to outlet (min) $T_t = \text{Item 6} / (\text{Item 10} * 60)$	N/A	N/A	N/A	N/A	N/A	N/A	N/A	N/A
<b>12</b> Total time of concentration (min) $T_c = \text{Item 5} + \text{Item 11}$	N/A	N/A	N/A	N/A	N/A	N/A	N/A	N/A
<b>13</b> Pre-developed time of concentration (min): N/A <i>Minimum of Item 12 pre-developed DMA</i>								
<b>14</b> Post-developed time of concentration (min): N/A <i>Minimum of Item 12 post-developed DMA</i>								
<b>15</b> Additional time of concentration needed to meet HCOC requirement (min): N/A $T_{C-HCOC} = (\text{Item 13} * 0.95) - \text{Item 14}$								

## Form 4.2-5 HCOC Assessment for Peak Runoff (DA 1)

Compute peak runoff for pre- and post-developed conditions

Variables	Pre-developed DA to Project Outlet (Use additional forms if more than 3 DMA)			Post-developed DA to Project Outlet (Use additional forms if more than 3 DMA)		
	DMA A	DMA B	DMA C	DMA A	DMA B	DMA C
<b>1</b> Rainfall Intensity for storm duration equal to time of concentration <i><math>I_{peak} = 10^{(LOG Form 4.2-1 Item 4 - 0.6 LOG Form 4.2-4 Item 5 / 60)}</math></i>	N/A	N/A	N/A	N/A	N/A	N/A
<b>2</b> Drainage Area of each DMA (Acres) <i>For DMA with outlet at project site outlet, include upstream DMA (Using example schematic in Form 3-1, DMA A will include drainage from DMA C)</i>	N/A	N/A	N/A	N/A	N/A	N/A
<b>3</b> Ratio of pervious area to total area <i>For DMA with outlet at project site outlet, include upstream DMA (Using example schematic in Form 3-1, DMA A will include drainage from DMA C)</i>	N/A	N/A	N/A	N/A	N/A	N/A
<b>4</b> Pervious area infiltration rate (in/hr) <i>Use pervious area CN and antecedent moisture condition with Appendix C-3 of the TGD for WQMP</i>	N/A	N/A	N/A	N/A	N/A	N/A
<b>5</b> Maximum loss rate (in/hr) <i><math>F_m = Item 3 * Item 4</math></i> <i>Use area-weighted <math>F_m</math> from DMA with outlet at project site outlet, include upstream DMA (Using example schematic in Form 3-1, DMA A will include drainage from DMA C)</i>	N/A	N/A	N/A	N/A	N/A	N/A
<b>6</b> Peak Flow from DMA (cfs) <i><math>Q_p = Item 2 * 0.9 * (Item 1 - Item 5)</math></i>	N/A	N/A	N/A	N/A	N/A	N/A
<b>7</b> Time of concentration adjustment factor for other DMA to site discharge point <i>Form 4.2-4 Item 12 DMA / Other DMA upstream of site discharge point (If ratio is greater than 1.0, then use maximum value of 1.0)</i>	DMA A	n/a	N/A	N/A	n/a	N/A
	DMA B	N/A	n/a	N/A	N/A	n/a
	DMA C	N/A	N/A	n/a	N/A	N/A
<b>8</b> Pre-developed $Q_p$ at $T_c$ for DMA A: N/A <i><math>Q_p = Item 6_{DMAA} + [Item 6_{DMAB} * (Item 1_{DMAA} - Item 5_{DMAB}) / (Item 1_{DMAB} - Item 5_{DMAB}) * Item 7_{DMAA/2}] + [Item 6_{DMAC} * (Item 1_{DMAA} - Item 5_{DMAC}) / (Item 1_{DMAC} - Item 5_{DMAC}) * Item 7_{DMAA/3}]</math></i>	<b>9</b> Pre-developed $Q_p$ at $T_c$ for DMA B: N/A <i><math>Q_p = Item 6_{DMAB} + [Item 6_{DMAA} * (Item 1_{DMAB} - Item 5_{DMAA}) / (Item 1_{DMAA} - Item 5_{DMAA}) * Item 7_{DMAB/1}] + [Item 6_{DMAC} * (Item 1_{DMAB} - Item 5_{DMAC}) / (Item 1_{DMAC} - Item 5_{DMAC}) * Item 7_{DMAB/3}]</math></i>		<b>10</b> Pre-developed $Q_p$ at $T_c$ for DMA C: N/A <i><math>Q_p = Item 6_{DMAC} + [Item 6_{DMAA} * (Item 1_{DMAC} - Item 5_{DMAA}) / (Item 1_{DMAA} - Item 5_{DMAA}) * Item 7_{DMAC/1}] + [Item 6_{DMAB} * (Item 1_{DMAC} - Item 5_{DMAB}) / (Item 1_{DMAB} - Item 5_{DMAB}) * Item 7_{DMAC/2}]</math></i>			
<b>10</b> Peak runoff from pre-developed condition confluence analysis (cfs): N/A <i>Maximum of Item 8, 9, and 10 (including additional forms as needed)</i>						
<b>11</b> Post-developed $Q_p$ at $T_c$ for DMA A: N/A <i>Same as Item 8 for post-developed values</i>	<b>12</b> Post-developed $Q_p$ at $T_c$ for DMA B: N/A <i>Same as Item 9 for post-developed values</i>		<b>13</b> Post-developed $Q_p$ at $T_c$ for DMA C: N/A <i>Same as Item 10 for post-developed values</i>			
<b>14</b> Peak runoff from post-developed condition confluence analysis (cfs): N/A <i>Maximum of Item 11, 12, and 13 (including additional forms as needed)</i>						
<b>15</b> Peak runoff reduction needed to meet HCOC Requirement (cfs): N/A <i><math>Q_{p-HCOC} = (Item 14 * 0.95) - Item 10</math></i>						

## 4.3 Project Conformance Analysis

Complete the following forms for each project site DA to document that the proposed LID BMPs conform to the project DCV developed to meet performance criteria specified in the MS<sub>4</sub> Permit (WQMP Template Section 4.2). For the LID DCV, the forms are ordered according to hierarchy of BMP selection as required by the MS<sub>4</sub> Permit (see Section 5.3.1 in the TGD for WQMP). The forms compute the following for on-site LID BMP:

- Site Design and Hydrologic Source Controls (Form 4.3-2)
- Retention and Infiltration (Form 4.3-3)
- Harvested and Use (Form 4.3-4) or
- Biotreatment (Form 4.3-5).

At the end of each form, additional fields facilitate the determination of the extent of mitigation provided by the specific BMP category, allowing for use of the next category of BMP in the hierarchy, if necessary.

The first step in the analysis, using Section 5.3.2.1 of the TGD for WQMP, is to complete Forms 4.3-1 and 4.3-3) to determine if retention and infiltration BMPs are infeasible for the project. For each feasibility criterion in Form 4.3-1, if the answer is “Yes,” provide all study findings that includes relevant calculations, maps, data sources, etc. used to make the determination of infeasibility.

Next, complete Forms 4.3-2 and 4.3-4 to determine the feasibility of applicable HSC and harvest and use BMPs, and, if their implementation is feasible, the extent of mitigation of the DCV.

If no site constraints exist that would limit the type of BMP to be implemented in a DA, evaluate the use of combinations of LID BMPs, including all applicable HSC BMPs to maximize on-site retention of the DCV. If no combination of BMP can mitigate the entire DCV, implement the single BMP type, or combination of BMP types, that maximizes on-site retention of the DCV within the minimum effective area.

If the combination of LID HSC, retention and infiltration, and harvest and use BMPs are unable to mitigate the entire DCV, then biotreatment BMPs may be implemented by the project proponent. If biotreatment BMPs are used, then they must be sized to provide sufficient capacity for effective treatment of the remainder of the volume-based performance criteria that cannot be achieved with LID BMPs (TGD for WQMP Section 5.4.4.2). **Under no circumstances shall any portion of the DCV be released from the site without effective mitigation and/or treatment.**

### Form 4.3-1 Infiltration BMP Feasibility (DA 1)

Feasibility Criterion – Complete evaluation for each DA on the Project Site

<sup>1</sup> Would infiltration BMP pose significant risk for groundwater related concerns? Yes  No   
*Refer to Section 5.3.2.1 of the TGD for WQMP*

If Yes, Provide basis: (attach)

<sup>2</sup> Would installation of infiltration BMP significantly increase the risk of geotechnical hazards? Yes  No   
 (Yes, if the answer to any of the following questions is yes, as established by a geotechnical expert):

- The location is less than 50 feet away from slopes steeper than 15 percent
- The location is less than eight feet from building foundations or an alternative setback.
- A study certified by a geotechnical professional or an available watershed study determines that stormwater infiltration would result in significantly increased risks of geotechnical hazards.

If Yes, Provide basis: (attach)

<sup>3</sup> Would infiltration of runoff on a Project site violate downstream water rights? Yes  No

If Yes, Provide basis: (attach)

<sup>4</sup> Is proposed infiltration facility located on hydrologic soil group (HSG) D soils or does the site geotechnical investigation indicate presence of soil characteristics, which support categorization as D soils? Yes  No

If Yes, Provide basis: (attach)

<sup>5</sup> Is the design infiltration rate, after accounting for safety factor of 2.0, below proposed facility less than 0.3 in/hr (accounting for soil amendments)? Yes  No

If Yes, Provide basis: (attach)

<sup>6</sup> Would on-site infiltration or reduction of runoff over pre-developed conditions be partially or fully inconsistent with watershed management strategies as defined in the WAP, or impair beneficial uses? Yes  No   
*See Section 3.5 of the TGD for WQMP and WAP*

If Yes, Provide basis: (attach)

<sup>7</sup> Any answer from Item 1 through Item 3 is “Yes”: Yes  No   
*If yes, infiltration of any volume is not feasible onsite. Proceed to Form 4.3-4, Harvest and Use BMP. If no, then proceed to Item 8 below.*

<sup>8</sup> Any answer from Item 4 through Item 6 is “Yes”: Yes  No   
*If yes, infiltration is permissible but is not required to be considered. Proceed to Form 4.3-2, Hydrologic Source Control BMP. If no, then proceed to Item 9, below.*

<sup>9</sup> All answers to Item 1 through Item 6 are “No”:  
*Infiltration of the full DCV is potentially feasible, LID infiltration BMP must be designed to infiltrate the full DCV to the MEP. Proceed to Form 4.3-2, Hydrologic Source Control BMP.*

### 4.3.1 Site Design Hydrologic Source Control BMP (N/A)

Section XI.E. of the Permit emphasizes the use of LID preventative measures; and the use of LID HSC BMPs reduces the portion of the DCV that must be addressed in downstream BMPs. Therefore, all applicable HSC shall be provided except where they are mutually exclusive with each other, or with other BMPs. Mutual exclusivity may result from overlapping BMP footprints such that either would be potentially feasible by itself, but both could not be implemented. Please note that while there are no numeric standards regarding the use of HSC, if a project cannot feasibly meet BMP sizing requirements or cannot fully address HCOCs, feasibility of all applicable HSC must be part of demonstrating that the BMP system has been designed to retain the maximum feasible portion of the DCV. Complete Form 4.3-2 to identify and calculate estimated retention volume from implementing site design HSC BMP. Refer to Section 5.4.1 in the TGD for more detailed guidance.

<b>Form 4.3-2 Site Design Hydrologic Source Control BMPs (DA 1)</b>			
<b>1</b> Implementation of Impervious Area Dispersion BMP (i.e. routing runoff from impervious to pervious areas), excluding impervious areas planned for routing to on-lot infiltration BMP: Yes <input type="checkbox"/> No <input checked="" type="checkbox"/> <i>If yes, complete Items 2-5; If no, proceed to Item 6</i>	DA DMA BMP Type	DA DMA BMP Type	DA DMA BMP Type <i>(Use additional forms for more BMPs)</i>
<b>2</b> Total impervious area draining to pervious area (ft <sup>2</sup> )			
<b>3</b> Ratio of pervious area receiving runoff to impervious area			
<b>4</b> Retention volume achieved from impervious area dispersion (ft <sup>3</sup> ) $V = \text{Item 2} * \text{Item 3} * (0.5/12)$ , assuming retention of 0.5 inches of runoff			
<b>5</b> Sum of retention volume achieved from impervious area dispersion (ft <sup>3</sup> ):		$V_{\text{retention}} = \text{Sum of Item 4 for all BMPs}$	
<b>6</b> Implementation of Localized On-lot Infiltration BMPs (e.g. on-lot rain gardens): Yes <input type="checkbox"/> No <input checked="" type="checkbox"/> <i>If yes, complete Items 7-13 for aggregate of all on-lot infiltration BMP in each DA; if no, proceed to Item 14</i>	DA DMA BMP Type	DA DMA BMP Type	DA DMA BMP Type <i>(Use additional forms for more BMPs)</i>
<b>7</b> Ponding surface area (ft <sup>2</sup> )			
<b>8</b> Ponding depth (ft)			
<b>9</b> Surface area of amended soil/gravel (ft <sup>2</sup> )			
<b>10</b> Average depth of amended soil/gravel (ft)			
<b>11</b> Average porosity of amended soil/gravel			
<b>12</b> Retention volume achieved from on-lot infiltration (ft <sup>3</sup> ) $V_{\text{retention}} = (\text{Item 7} * \text{Item 8}) + (\text{Item 9} * \text{Item 10} * \text{Item 11})$			
<b>13</b> Runoff volume retention from on-lot infiltration (ft <sup>3</sup> ): 0		$V_{\text{retention}} = \text{Sum of Item 12 for all BMPs}$	

<b>Form 4.3-2 cont. Site Design Hydrologic Source Control BMPs (DA 1)</b>			
<b>14</b> Implementation of evapotranspiration BMP (green, brown, or blue roofs): Yes <input type="checkbox"/> No <input checked="" type="checkbox"/> <i>If yes, complete Items 15-20. If no, proceed to Item 21</i>	DA DMA BMP Type	DA DMA BMP Type	DA DMA BMP Type <i>(Use additional forms for more BMPs)</i>
<b>15</b> Rooftop area planned for ET BMP (ft <sup>2</sup> )			
<b>16</b> Average wet season ET demand (in/day) <i>Use local values, typical ~ 0.1</i>			
<b>17</b> Daily ET demand (ft <sup>3</sup> /day) <i>Item 15 * (Item 16 / 12)</i>			
<b>18</b> Drawdown time (hrs) <i>Copy Item 6 in Form 4.2-1</i>			
<b>19</b> Retention Volume (ft <sup>3</sup> ) <i>V<sub>retention</sub> = Item 17 * (Item 18 / 24)</i>			
<b>20</b> Runoff volume retention from evapotranspiration BMPs (ft <sup>3</sup> ): <span style="float: right;"><i>V<sub>retention</sub> = Sum of Item 19 for all BMPs</i></span>			
<b>21</b> Implementation of Street Trees: Yes <input type="checkbox"/> No <input checked="" type="checkbox"/> <i>If yes, complete Items 22-25. If no, proceed to Item 26</i>	DA DMA BMP Type	DA DMA BMP Type	DA DMA BMP Type <i>(Use additional forms for more BMPs)</i>
<b>22</b> Number of Street Trees			
<b>23</b> Average canopy cover over impervious area (ft <sup>2</sup> )			
<b>24</b> Runoff volume retention from street trees (ft <sup>3</sup> ) <i>V<sub>retention</sub> = Item 22 * Item 23 * (0.05/12) assume runoff retention of 0.05 inches</i>			
<b>25</b> Runoff volume retention from street tree BMPs (ft <sup>3</sup> ): <span style="float: right;"><i>V<sub>retention</sub> = Sum of Item 24 for all BMPs</i></span>			
<b>26</b> Implementation of residential rain barrel/cisterns: Yes <input type="checkbox"/> No <input checked="" type="checkbox"/> <i>If yes, complete Items 27-29; If no, proceed to Item 30</i>	DA DMA BMP Type	DA DMA BMP Type	DA DMA BMP Type <i>(Use additional forms for more BMPs)</i>
<b>27</b> Number of rain barrels/cisterns			
<b>28</b> Runoff volume retention from rain barrels/cisterns (ft <sup>3</sup> ) <i>V<sub>retention</sub> = Item 27 * 3</i>			
<b>29</b> Runoff volume retention from residential rain barrels/Cisterns (ft <sup>3</sup> ): 0 <span style="float: right;"><i>V<sub>retention</sub> = Sum of Item 28 for all BMPs</i></span>			
<b>30</b> Total Retention Volume from Site Design Hydrologic Source Control BMPs: 0 <span style="float: right;"><i>Sum of Items 5, 13, 20, 25 and 29</i></span>			

### 4.3.2 Infiltration BMPs

Use Form 4.3-3 to compute on-site retention of runoff from proposed retention and infiltration BMPs. Volume retention estimates are sensitive to the percolation rate used, which determines the amount of runoff that can be infiltrated within the specified drawdown time. The infiltration safety factor reduces field measured percolation to account for potential inaccuracy associated with field measurements, declining BMP performance over time, and compaction during construction. Appendix D of the TGD for WQMP provides guidance on estimating an appropriate safety factor to use in Form 4.3-3.

If site constraints limit the use of BMPs to a single type and implementation of retention and infiltration BMPs mitigate no more than 40% of the DCV, then they are considered infeasible and the Project Proponent may evaluate the effectiveness of BMPs lower in the LID hierarchy of use (Section 5.5.1 of the TGD for WQMP)

If implementation of infiltrations BMPs is feasible as determined using Form 4.3-1, then LID infiltration BMPs shall be implemented to the MEP (section 4.1 of the TGD for WQMP).



### Form 4.3-3 Infiltration LID BMP - including underground BMPs (DA 1)

<b>1</b> Remaining LID DCV not met by site design HSC BMP (ft <sup>3</sup> ): 60,192 $V_{unmet} = \text{Form 4.2-1 Item 7} - \text{Form 4.3-2 Item 30}$			
BMP Type Use columns to the right to compute runoff volume retention from proposed infiltration BMP (select BMP from Table 5-4 in TGD for WQMP) - Use additional forms for more BMPs	DA 1 BMP Type ug	DA DMA BMP Type	DA DMA BMP Type (Use additional forms for more BMPs)
<b>2</b> Infiltration rate of underlying soils (in/hr) See Section 5.4.2 and Appendix D of the TGD for WQMP for minimum requirements for assessment methods	20.00	N/A	N/A
<b>3</b> Infiltration safety factor See TGD Section 5.4.2 and Appendix D	3	N/A	N/A
<b>4</b> Design percolation rate (in/hr) $P_{design} = \text{Item 2} / \text{Item 3}$	6.67	N/A	N/A
<b>5</b> Ponded water drawdown time (hr) Copy Item 6 in Form 4.2-1	48	N/A	N/A
<b>6</b> Maximum ponding depth (ft) BMP specific, see Table 5-4 of the TGD for WQMP for BMP design details	9	N/A	N/A
<b>7</b> Ponding Depth (ft) $d_{BMP} = \text{Minimum of } (1/12 * \text{Item 4} * \text{Item 5}) \text{ or Item 6}$	9	N/A	N/A
<b>8</b> Infiltrating surface area, $SA_{BMP}$ (ft <sup>2</sup> ) the lesser of the area needed for infiltration of full DCV or minimum space requirements from Table 5.7 of the TGD for WQMP	9,612	N/A	N/A
<b>9</b> Amended soil depth, $d_{media}$ (ft) Only included in certain BMP types, see Table 5-4 in the TGD for WQMP for reference to BMP design details	N/A	N/A	N/A
<b>10</b> Amended soil porosity	N/A	N/A	N/A
<b>11</b> Gravel depth, $d_{media}$ (ft) Only included in certain BMP types, see Table 5-4 of the TGD for WQMP for BMP design details	N/A	N/A	N/A
<b>12</b> Gravel porosity	N/A	N/A	N/A
<b>13</b> Duration of storm as basin is filling (hrs) Typical ~ 3hrs	N/A	N/A	N/A
<b>14</b> Above Ground Retention Volume (ft <sup>3</sup> ) $V_{retention} = \text{Item 8} * [\text{Item 7} + (\text{Item 9} * \text{Item 10}) + (\text{Item 11} * \text{Item 12}) + (\text{Item 13} * (\text{Item 4} / 12))]$	0	N/A	N/A
<b>15</b> Underground Retention Volume (ft <sup>3</sup> ) Volume determined using manufacturer's specifications and calculations	60,962 (See Attachment B)	N/A	N/A
<b>16</b> Total Retention Volume from LID Infiltration BMPs: 60,962 (Sum of Items 14 and 15 for all infiltration BMP included in plan)			
<b>17</b> Fraction of DCV achieved with infiltration BMP: 102% $\text{Retention}\% = \text{Item 16} / \text{Form 4.2-1 Item 7}$			
<b>18</b> Is full LID DCV retained onsite with combination of hydrologic source control and LID retention/infiltration BMPs? Yes <input checked="" type="checkbox"/> No <input type="checkbox"/> If yes, demonstrate conformance using Form 4.3-10; If no, then reduce Item 3, Factor of Safety to 2.0 and increase Item 8, Infiltrating Surface Area, such that the portion of the site area used for retention and infiltration BMPs equals or exceeds the minimum effective area thresholds (Table 5-7 of the TGD for WQMP) for the applicable category of development and repeat all above calculations.			

### 4.3.3 Harvest and Use BMP (N/A)

Harvest and use BMP may be considered if the full LID DCV cannot be met by maximizing infiltration BMPs. Use Form 4.3-4 to compute on-site retention of runoff from proposed harvest and use BMPs.

Volume retention estimates for harvest and use BMPs are sensitive to the on-site demand for captured stormwater. Since irrigation water demand is low in the wet season, when most rainfall events occur in San Bernardino County, the volume of water that can be used within a specified drawdown period is relatively low. The bottom portion of Form 4.3-4 facilitates the necessary computations to show infeasibility if a minimum incremental benefit of 40 percent of the LID DCV would not be achievable with MEP implementation of on-site harvest and use of stormwater (Section 5.5.4 of the TGD for WQMP).

<b>Form 4.3-4 Harvest and Use BMPs (DA 1)</b>			
<b>1</b> Remaining LID DCV not met by site design HSC or infiltration BMP (ft <sup>3</sup> ): 0 <i>V<sub>unmet</sub> = Form 4.2-1 Item 7 - Form 4.3-2 Item 30 - Form 4.3-3 Item 16</i>			
BMP Type(s) <i>Compute runoff volume retention from proposed harvest and use BMP (Select BMPs from Table 5-4 of the TGD for WQMP) - Use additional forms for more BMPs</i>	DA BMP Type	DMA BMP Type	DA DMA BMP Type <i>(Use additional forms for more BMPs)</i>
<b>2</b> Describe cistern or runoff detention facility	N/A	N/A	N/A
<b>3</b> Storage volume for proposed detention type (ft <sup>3</sup> ) <i>Volume of cistern</i>	N/A	N/A	N/A
<b>4</b> Landscaped area planned for use of harvested stormwater (ft <sup>2</sup> )	N/A	N/A	N/A
<b>5</b> Average wet season daily irrigation demand (in/day) <i>Use local values, typical ~ 0.1 in/day</i>	N/A	N/A	N/A
<b>6</b> Daily water demand (ft <sup>3</sup> /day) <i>Item 4 * (Item 5 / 12)</i>	N/A	N/A	N/A
<b>7</b> Drawdown time (hrs) <i>Copy Item 6 from Form 4.2-1</i>	N/A	N/A	N/A
<b>8</b> Retention Volume (ft <sup>3</sup> ) <i>V<sub>retention</sub> = Minimum of (Item 3) or (Item 6 * (Item 7 / 24))</i>	N/A	N/A	N/A
<b>9</b> Total Retention Volume (ft <sup>3</sup> ) from Harvest and Use BMP = 0 <i>Sum of Item 8 for all harvest and use BMP included in plan</i>			
<b>10</b> Is the full DCV retained with a combination of LID HSC, retention and infiltration, and harvest & use BMPs? Yes <input checked="" type="checkbox"/> No <input type="checkbox"/> <i>If yes, demonstrate conformance using Form 4.3-10. If no, then re-evaluate combinations of all LID BMP and optimize their implementation such that the maximum portion of the DCV is retained on-site (using a single BMP type or combination of BMP types). If the full DCV cannot be mitigated after this optimization process, proceed to Section 4.3.4.</i>			

### 4.3.4 Biotreatment BMP (N/A)

Biotreatment BMPs may be considered if the full LID DCV cannot be met by maximizing retention and infiltration, and harvest and use BMPs. A key consideration when using biotreatment BMP is the effectiveness of the proposed BMP in addressing the pollutants of concern for the project (see Table 5-5 of the TGD for WQMP).

Use Form 4.3-5 to summarize the potential for volume based and/or flow based biotreatment options to biotreat the remaining unmet LID DCV w. Biotreatment computations are included as follows:

- Use Form 4.3-6 to compute biotreatment in small volume based biotreatment BMP (e.g. bioretention w/underdrains);
- Use Form 4.3-7 to compute biotreatment in large volume based biotreatment BMP (e.g. constructed wetlands);
- Use Form 4.3-8 to compute sizing criteria for flow-based biotreatment BMP (e.g. bioswales)

<b>Form 4.3-5 Selection and Evaluation of Biotreatment BMP (DA 1)</b>		
<p><b>1</b> Remaining LID DCV not met by site design HSC, infiltration, or harvest and use BMP for potential biotreatment (ft<sup>3</sup>): 0 Form 4.2-1 Item 7 - Form 4.3-2 Item 30 – Form 4.3-3 Item 16- Form 4.3-4 Item 9</p>	<p>List pollutants of concern <i>Copy from Form 2.3-1.</i></p>	
<p><b>2</b> Biotreatment BMP Selected <i>(Select biotreatment BMP(s) necessary to ensure all pollutants of concern are addressed through Unit Operations and Processes, described in Table 5-5 of the TGD for WQMP)</i></p>	<p style="text-align: center;">Volume-based biotreatment <i>Use Forms 4.3-6 and 4.3-7 to compute treated volume</i></p> <p><input type="checkbox"/> Bioretention with underdrain <input type="checkbox"/> Planter box with underdrain <input type="checkbox"/> Constructed wetlands <input type="checkbox"/> Wet extended detention <input type="checkbox"/> Dry extended detention</p>	<p style="text-align: center;">Flow-based biotreatment <i>Use Form 4.3-8 to compute treated volume</i></p> <p><input type="checkbox"/> Vegetated swale <input type="checkbox"/> Vegetated filter strip <input type="checkbox"/> Proprietary biotreatment</p>
<p><b>3</b> Volume biotreated in volume based biotreatment BMP (ft<sup>3</sup>): 0 Form 4.3-6 Item 15 + Form 4.3-7 Item 13</p>	<p><b>4</b> Compute remaining LID DCV with implementation of volume based biotreatment BMP (ft<sup>3</sup>): 0 Item 1 – Item 3</p>	<p><b>5</b> Remaining fraction of LID DCV for sizing flow based biotreatment BMP: 0% Item 4 / Item 1</p>
<p><b>6</b> Flow-based biotreatment BMP capacity provided (cfs): <i>Use Figure 5-2 of the TGD for WQMP to determine flow capacity required to provide biotreatment of remaining percentage of unmet LID DCV (Item 5), for the project’s precipitation zone (Form 3-1 Item 1)</i></p>		
<p><b>7</b> Metrics for MEP determination:</p> <ul style="list-style-type: none"> <li>• Provided a WQMP with the portion of site area used for suite of LID BMP equal to minimum thresholds in Table 5-7 of the TGD for WQMP for the proposed category of development: <input type="checkbox"/> <i>If maximized on-site retention BMPs is feasible for partial capture, then LID BMP implementation must be optimized to retain and infiltrate the maximum portion of the DCV possible within the prescribed minimum effective area. The remaining portion of the DCV shall then be mitigated using biotreatment BMP.</i></li> </ul>		

<b>Form 4.3-6 Volume Based Biotreatment (DA 1) – Bioretention and Planter Boxes with Underdrains</b>			
Biotreatment BMP Type <i>(Bioretention w/underdrain, planter box w/underdrain, other comparable BMP)</i>	DA    DMA BMP Type	DA    DMA BMP Type	DA    DMA BMP Type <i>(Use additional forms for more BMPs)</i>
<b>1</b> Pollutants addressed with BMP <i>List all pollutant of concern that will be effectively reduced through specific Unit Operations and Processes described in Table 5-5 of the TGD for WQMP</i>	N/A	N/A	N/A
<b>2</b> Amended soil infiltration rate <i>Typical ~ 5.0</i>	N/A	N/A	N/A
<b>3</b> Amended soil infiltration safety factor <i>Typical ~ 2.0</i>	N/A	N/A	N/A
<b>4</b> Amended soil design percolation rate (in/hr) $P_{design} = \text{Item 2} / \text{Item 3}$	N/A	N/A	N/A
<b>5</b> Ponded water drawdown time (hr) <i>Copy Item 6 from Form 4.2-1</i>	N/A	N/A	N/A
<b>6</b> Maximum ponding depth (ft) <i>see Table 5-6 of the TGD for WQMP for reference to BMP design details</i>	N/A	N/A	N/A
<b>7</b> Ponding Depth (ft) $d_{BMP} = \text{Minimum of } (1/12 * \text{Item 4} * \text{Item 5}) \text{ or Item 6}$	N/A	N/A	N/A
<b>8</b> Amended soil surface area (ft <sup>2</sup> )	N/A	N/A	N/A
<b>9</b> Amended soil depth (ft) <i>see Table 5-6 of the TGD for WQMP for reference to BMP design details</i>	N/A	N/A	N/A
<b>10</b> Amended soil porosity, <i>n</i>	N/A	N/A	N/A
<b>11</b> Gravel depth (ft) <i>see Table 5-6 of the TGD for WQMP for reference to BMP design details</i>	N/A	N/A	N/A
<b>12</b> Gravel porosity, <i>n</i>	N/A	N/A	N/A
<b>13</b> Duration of storm as basin is filling (hrs) <i>Typical ~ 3hrs</i>	N/A	N/A	N/A
<b>14</b> Biotreated Volume (ft <sup>3</sup> ) $V_{biotreated} = \text{Item 8} * [( \text{Item 7} / 2 ) + ( \text{Item 9} * \text{Item 10} ) + ( \text{Item 11} * \text{Item 12} ) + ( \text{Item 13} * ( \text{Item 4} / 12 ) )]$	N/A	N/A	N/A
<b>15</b> Total biotreated volume from bioretention and/or planter box with underdrains BMP: 0 <i>Sum of Item 14 for all volume-based BMPs included in this form</i>			

### Form 4.3-7 Volume Based Biotreatment (DA 1) – Constructed Wetlands and Extended Detention

Biotreatment BMP Type <i>Constructed wetlands, extended wet detention, extended dry detention, or other comparable proprietary BMP. If BMP includes multiple modules (e.g. forebay and main basin), provide separate estimates for storage and pollutants treated in each module.</i>	DA DMA BMP Type		DA DMA BMP Type <i>(Use additional forms for more BMPs)</i>	
	Forebay	Basin	Forebay	Basin
<b>1</b> Pollutants addressed with BMP forebay and basin <i>List all pollutant of concern that will be effectively reduced through specific Unit Operations and Processes described in Table 5-5 of the TGD for WQMP</i>	N/A	N/A	N/A	N/A
<b>2</b> Bottom width (ft)	N/A	N/A	N/A	N/A
<b>3</b> Bottom length (ft)	N/A	N/A	N/A	N/A
<b>4</b> Bottom area (ft <sup>2</sup> ) $A_{bottom} = \text{Item 2} * \text{Item 3}$	N/A	N/A	N/A	N/A
<b>5</b> Side slope (ft/ft)	N/A	N/A	N/A	N/A
<b>6</b> Depth of storage (ft)	N/A	N/A	N/A	N/A
<b>7</b> Water surface area (ft <sup>2</sup> ) $A_{surface} = (\text{Item 2} + (2 * \text{Item 5} * \text{Item 6})) * (\text{Item 3} + (2 * \text{Item 5} * \text{Item 6}))$	N/A	N/A	N/A	N/A
<b>8</b> Storage volume (ft <sup>3</sup> ) <i>For BMP with a forebay, ensure fraction of total storage is within ranges specified in BMP specific fact sheets, see Table 5-6 of the TGD for WQMP for reference to BMP design details</i> $V = \text{Item 6} / 3 * [\text{Item 4} + \text{Item 7} + (\text{Item 4} * \text{Item 7})^{0.5}]$	N/A	N/A	N/A	N/A
<b>9</b> Drawdown Time (hrs) <i>Copy Item 6 from Form 2.1</i>	N/A		N/A	
<b>10</b> Outflow rate (cfs) $Q_{BMP} = (\text{Item 8}_{forebay} + \text{Item 8}_{basin}) / (\text{Item 9} * 3600)$	N/A		N/A	
<b>11</b> Duration of design storm event (hrs)	N/A		N/A	
<b>12</b> Biotreated Volume (ft <sup>3</sup> ) $V_{biotreated} = (\text{Item 8}_{forebay} + \text{Item 8}_{basin}) + (\text{Item 10} * \text{Item 11} * 3600)$	N/A		N/A	
<b>13</b> Total biotreated volume from constructed wetlands, extended dry detention, or extended wet detention : 0 <i>(Sum of Item 12 for all BMP included in plan)</i>				

<b>Form 4.3-8 Flow Based Biotreatment (DA 1)</b>			
Biotreatment BMP Type <i>Vegetated swale, vegetated filter strip, or other comparable proprietary BMP</i>	DA    DMA BMP Type	DA    DMA BMP Type	DA    DMA BMP Type <i>(Use additional forms for more BMPs)</i>
<b>1</b> Pollutants addressed with BMP <i>List all pollutant of concern that will be effectively reduced through specific Unit Operations and Processes described in TGD Table 5-5</i>	N/A	N/A	N/A
<b>2</b> Flow depth for water quality treatment (ft) <i>BMP specific, see Table 5-6 of the TGD for WQMP for reference to BMP design details</i>	N/A	N/A	N/A
<b>3</b> Bed slope (ft/ft) <i>BMP specific, see Table 5-6 of the TGD for WQMP for reference to BMP design details</i>	N/A	N/A	N/A
<b>4</b> Manning's roughness coefficient	N/A	N/A	N/A
<b>5</b> Bottom width (ft) <i><math>b_w = (\text{Form 4.3-5 Item 6} * \text{Item 4}) / (1.49 * \text{Item 2}^{1.67} * \text{Item 3}^{0.5})</math></i>	N/A	N/A	N/A
<b>6</b> Side Slope (ft/ft) <i>BMP specific, see Table 5-6 of the TGD for WQMP for reference to BMP design details</i>	N/A	N/A	N/A
<b>7</b> Cross sectional area (ft <sup>2</sup> ) <i><math>A = (\text{Item 5} * \text{Item 2}) + (\text{Item 6} * \text{Item 2}^{0.2})</math></i>	N/A	N/A	N/A
<b>8</b> Water quality flow velocity (ft/sec) <i><math>V = \text{Form 4.3-5 Item 6} / \text{Item 7}</math></i>	N/A	N/A	N/A
<b>9</b> Hydraulic residence time (min) <i>Pollutant specific, see Table 5-6 of the TGD for WQMP for reference to BMP design details</i>	N/A	N/A	N/A
<b>10</b> Length of flow based BMP (ft) <i><math>L = \text{Item 8} * \text{Item 9} * 60</math></i>	N/A	N/A	N/A
<b>11</b> Water surface area at water quality flow depth (ft <sup>2</sup> ) <i><math>SA_{top} = (\text{Item 5} + (2 * \text{Item 2} * \text{Item 6})) * \text{Item 10}</math></i>	N/A	N/A	N/A

### 4.3.5 Conformance Summary

Complete Form 4.3-9 to demonstrate how on-site LID DCV is met with proposed site design hydrologic source control, infiltration, harvest and use, and/or biotreatment BMP. The bottom line of the form is used to describe the basis for infeasibility determination for on-site LID BMP to achieve full LID DCV, and provides methods for computing remaining volume to be addressed in an alternative compliance plan. If the project has more than one outlet, then complete additional versions of this form for each outlet.

<b>Form 4.3-9 Conformance Summary and Alternative Compliance Volume Estimate (DA 1)</b>	
<b>1</b>	Total LID DCV for the Project DA-1 (ft <sup>3</sup> ): 60,192 <i>Copy Item 7 in Form 4.2-1</i>
<b>2</b>	On-site retention with site design hydrologic source control LID BMP (ft <sup>3</sup> ): 0 <i>Copy Item 30 in Form 4.3-2</i>
<b>3</b>	On-site retention with LID infiltration BMP (ft <sup>3</sup> ): 60,962 <i>Copy Item 16 in Form 4.3-3</i>
<b>4</b>	On-site retention with LID harvest and use BMP (ft <sup>3</sup> ): 0 <i>Copy Item 9 in Form 4.3-4</i>
<b>5</b>	On-site biotreatment with volume based biotreatment BMP (ft <sup>3</sup> ): 0 <i>Copy Item 3 in Form 4.3-5</i>
<b>6</b>	Flow capacity provided by flow based biotreatment BMP (cfs): 0 <i>Copy Item 6 in Form 4.3-5</i>
<b>7</b>	<p>LID BMP performance criteria are achieved if answer to any of the following is "Yes":</p> <ul style="list-style-type: none"> <li>• Full retention of LID DCV with site design HSC, infiltration, or harvest and use BMP: Yes <input checked="" type="checkbox"/> No <input type="checkbox"/> <i>If yes, sum of Items 2, 3, and 4 is greater than Item 1</i></li> <li>• Combination of on-site retention BMPs for a portion of the LID DCV and volume-based biotreatment BMP that address all pollutants of concern for the remaining LID DCV: Yes <input checked="" type="checkbox"/> No <input type="checkbox"/> <i>If yes, a) sum of Items 2, 3, 4, and 5 is greater than Item 1, and Items 2, 3 and 4 are maximized; or b) Item 6 is greater than Form 4.3--5 Item 6 and Items 2, 3 and 4 are maximized</i></li> <li>▪ On-site retention and infiltration is determined to be infeasible and biotreatment BMP provide biotreatment for all pollutants of concern for full LID DCV: Yes <input type="checkbox"/> No <input checked="" type="checkbox"/> <i>If yes, Form 4.3-1 Items 7 and 8 were both checked yes</i></li> </ul>
<b>8</b>	<p>If the LID DCV is not achieved by any of these means, then the project may be allowed to develop an alternative compliance plan. Check box that describes the scenario which caused the need for alternative compliance:</p> <ul style="list-style-type: none"> <li>• Combination of HSC, retention and infiltration, harvest and use, and biotreatment BMPs provide less than full LID DCV capture: <input type="checkbox"/> <i>Checked yes for Form 4.3-5 Item 7, Item 6 is zero, and sum of Items 2, 3, 4, and 5 is less than Item 1. If so, apply water quality credits and calculate volume for alternative compliance, <math>V_{alt} = (Item\ 1 - Item\ 2 - Item\ 3 - Item\ 4 - Item\ 5) * (100 - Form\ 2.4-1\ Item\ 2)\%</math></i></li> <li>• An approved Watershed Action Plan (WAP) demonstrates that water quality and hydrologic impacts of urbanization are more effective when managed in at an off-site facility: <input checked="" type="checkbox"/> <i>Attach appropriate WAP section, including technical documentation, showing effectiveness comparisons for the project site and regional watershed</i></li> </ul>

### 4.3.6 Hydromodification Control BMP (N/A)

Use Form 4.3-10 to compute the remaining runoff volume retention, after LID BMP are implemented, needed to address HCOC, and the increase in time of concentration and decrease in peak runoff necessary to meet targets for protection of waterbodies with a potential HCOC. Describe hydromodification control BMP that address HCOC, which may include off-site BMP and/or in-stream controls. Section 5.6 of the TGD for WQMP provides additional details on selection and evaluation of hydromodification control BMP.

<b>Form 4.3-10 Hydromodification Control BMPs (DA 1)</b>	
<p><b>1</b> Volume reduction needed for HCOC performance criteria (ft<sup>3</sup>): 0 <i>(Form 4.2-2 Item 4 * 0.95) – Form 4.2-2 Item 1</i></p>	<p><b>2</b> On-site retention with site design hydrologic source control, infiltration, and harvest and use LID BMP (ft<sup>3</sup>): <i>Sum of Form 4.3-9 Items 2, 3, and 4 Evaluate option to increase implementation of on-site retention in Forms 4.3-2, 4.3-3, and 4.3-4 in excess of LID DCV toward achieving HCOC volume reduction</i></p>
<p><b>3</b> Remaining volume for HCOC volume capture (ft<sup>3</sup>): 0 <i>Item 1 – Item 2</i></p>	<p><b>4</b> Volume capture provided by incorporating additional on-site or off-site retention BMPs (ft<sup>3</sup>): 0 <i>Existing downstream BMP may be used to demonstrate additional volume capture (if so, attach to this WQMP a hydrologic analysis showing how the additional volume would be retained during a 2-yr storm event for the regional watershed)</i></p>
<p><b>5</b> If Item 4 is less than Item 3, incorporate in-stream controls on downstream waterbody segment to prevent impacts due to hydromodification <input type="checkbox"/> <i>Attach in-stream control BMP selection and evaluation to this WQMP</i></p>	
<p><b>6</b> Is Form 4.2-2 Item 11 less than or equal to 5%: Yes <input type="checkbox"/> No <input type="checkbox"/>  <i>If yes, HCOC performance criteria is achieved. If no, select one or more mitigation options below:</i></p> <ul style="list-style-type: none"> <li>• Demonstrate increase in time of concentration achieved by proposed LID site design, LID BMP, and additional on-site or off-site retention BMP <input type="checkbox"/>  <i>BMP upstream of a waterbody segment with a potential HCOC may be used to demonstrate increased time of concentration through hydrograph attenuation (if so, show that the hydraulic residence time provided in BMP for a 2-year storm event is equal or greater than the addition time of concentration requirement in Form 4.2-4 Item 15)</i></li> <li>• Increase time of concentration by preserving pre-developed flow path and/or increase travel time by reducing slope and increasing cross-sectional area and roughness for proposed on-site conveyance facilities <input type="checkbox"/></li> <li>• Incorporate appropriate in-stream controls for downstream waterbody segment to prevent impacts due to hydromodification, in a plan approved and signed by a licensed engineer in the State of California <input type="checkbox"/></li> </ul>	
<p><b>7</b> Form 4.2-2 Item 12 less than or equal to 5%: Yes <input type="checkbox"/> No <input type="checkbox"/>  <i>If yes, HCOC performance criteria is achieved. If no, select one or more mitigation options below:</i></p> <ul style="list-style-type: none"> <li>• Demonstrate reduction in peak runoff achieved by proposed LID site design, LID BMPs, and additional on-site or off-site retention BMPs <input type="checkbox"/>  <i>BMPs upstream of a waterbody segment with a potential HCOC may be used to demonstrate additional peak runoff reduction through hydrograph attenuation (if so, attach to this WQMP, a hydrograph analysis showing how the peak runoff would be reduced during a 2-yr storm event)</i></li> <li>• Incorporate appropriate in-stream controls for downstream waterbody segment to prevent impacts due to hydromodification, in a plan approved and signed by a licensed engineer in the State of California <input type="checkbox"/></li> </ul>	



## 4.4 Alternative Compliance Plan (if applicable)

Describe an alternative compliance plan (if applicable) for projects not fully able to infiltrate, harvest and use, or biotreat the DCV via on-site LID practices. A project proponent must develop an alternative compliance plan to address the remainder of the LID DCV. Depending on project type some projects may qualify for water quality credits that can be applied to reduce the DCV that must be treated prior to development of an alternative compliance plan (see Form 2.4-1, Water Quality Credits). Form 4.3-9 Item 8 includes instructions on how to apply water quality credits when computing the DCV that must be met through alternative compliance. Alternative compliance plans may include one or more of the following elements:

- On-site structural treatment control BMP - All treatment control BMP should be located as close to possible to the pollutant sources and should not be located within receiving waters;
- Off-site structural treatment control BMP - Pollutant removal should occur prior to discharge of runoff to receiving waters;
- Urban runoff fund or In-lieu program, if available

Depending upon the proposed alternative compliance plan, approval by the executive officer may or may not be required (see Section 6 of the TGD for WQMP).

## Section 5 Inspection and Maintenance Responsibility for Post Construction BMP

All BMP included as part of the project WQMP are required to be maintained through regular scheduled inspection and maintenance (refer to Section 8, Post Construction BMP Requirements, in the TGD for WQMP). Fully complete Form 5-1 summarizing all BMP included in the WQMP. Attach additional forms as needed. The WQMP shall also include a detailed Operation and Maintenance Plan for all BMP and may require a Maintenance Agreement (consult the jurisdiction's LIP). If a Maintenance Agreement is required, it must also be attached to the WQMP.

<b>Form 5-1 BMP Inspection and Maintenance (use additional forms as necessary)</b>			
BMP	Responsible Party(s)	Inspection/ Maintenance Activities Required	Minimum Frequency of Activities
Underground Infiltration System	Owner	<ul style="list-style-type: none"> <li>- Inspect/maintain underground infiltration systems</li> <li>- Isolator row for collected trash, sediments and/or debris. Remove trash, sediments and debris by jet-vac and pump and dispose of trash, sediments and debris in a legal manner</li> <li>- Inspect system for standing water. If system has standing water, perform re-inspection within 48 hours. If system still has standing water then the system shall be jet-vacuumed and pumped and removed debris shall be disposed of in a legal manner</li> </ul>	Bi-monthly and Prior to storm event and 48 hours after storm has passed
Loading Dock and Parking Lot Sweeping	Owner	Sweep loading dock, parking lot, and truck courts	Monthly or as needed
Catch Basin Filter	Owner	<ul style="list-style-type: none"> <li>- Inspect and maintain catch basin filters as required.</li> <li>- Inspect catch basin bottom for debris</li> <li>- Remove debris and dispose as required</li> </ul>	Quarterly

**Water Quality Management Plan (WQMP)**

Loading Dock	Owner	<ul style="list-style-type: none"> <li>- Inspect loading dock for trash debris and sediments</li> <li>- Inspect loading dock for evidence of spills and broken containers</li> <li>- Clean up spills and dispose of collected material in a legal manner</li> </ul>	Weekly
Planting	Owner	<ul style="list-style-type: none"> <li>- Inspect health of planting and erosion of landscape area</li> <li>- Trimming trees and bushes when needed</li> </ul>	Monthly
Efficient Irrigation	Owner	<ul style="list-style-type: none"> <li>- Inspect irrigation system general operation and durations</li> <li>- Repair damaged sprinkler and drip irrigation lines as needed</li> <li>- Reduce durations during the winter season to prevent over irrigation</li> </ul>	Monthly
Trash Storage Areas and Litter Control (SD-32)	Owner	<ul style="list-style-type: none"> <li>- Inspect trash container, lids, screens, and clean trash storage areas</li> </ul>	Weekly
Employee Training / Education Program	Owner	<ul style="list-style-type: none"> <li>- Building tenants to provide BMP training and hand out educational materials.</li> </ul>	Annually or upon hire
Roof Runoff Controls (SD-11)	Owner	<ul style="list-style-type: none"> <li>- Inspect/repair roof drains</li> </ul>	Quarterly
Storm drain system signage	Owner	<ul style="list-style-type: none"> <li>- Inspect catch basin signage for faded or lost signs</li> <li>- Repair or replace signage as needed</li> </ul>	Annually
CDS Treatment Unit	Owner	<ul style="list-style-type: none"> <li>-Inspect system for sediment, floating trash and debris monthly or 48 hours after storm has passed.</li> </ul>	Monthly and Prior to storm event and 48 hours after storm has passed.

## Section 6 WQMP Attachments

### 6.1. Site Plan and Drainage Plan

Include a site plan and drainage plan sheet set containing the following minimum information:

- Project location
- Site boundary
- Land uses and land covers, as applicable
- Suitability/feasibility constraints
- Structural Source Control BMP locations
- Site Design Hydrologic Source Control BMP locations
- LID BMP details
- Drainage delineations and flow information
- Drainage connections

### 6.2 Electronic Data Submittal

Minimum requirements include submittal of PDF exhibits in addition to hard copies. Format must not require specialized software to open. If the local jurisdiction requires specialized electronic document formats (as described in their local Local Implementation Plan), this section will describe the contents (e.g., layering, nomenclature, geo-referencing, etc.) of these documents so that they may be interpreted efficiently and accurately.

### 6.3 Post Construction

Attach all O&M Plans and Maintenance Agreements for BMP to the WQMP.

### 6.4 Other Supporting Documentation

- BMP Educational Materials
- Activity Restriction – C, C&R's & Lease Agreements

# **Attachment A**

## **Vicinity Map & WQMP Site Plan**

**LEGEND**

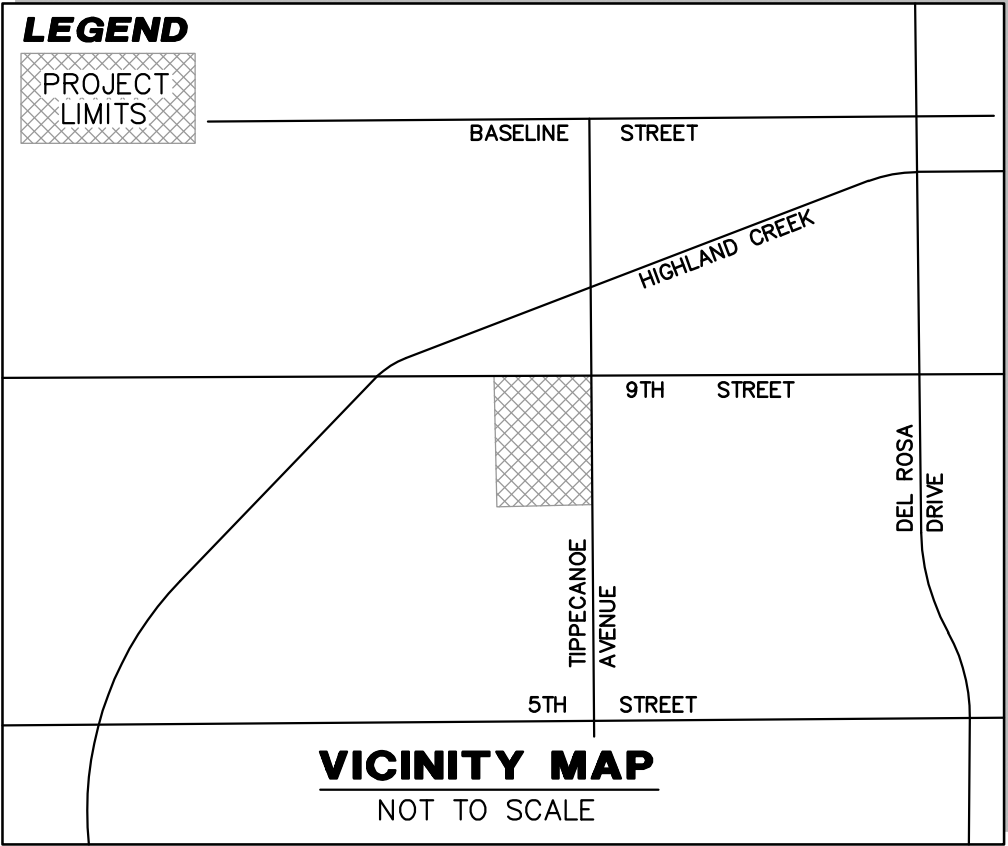

**VICINITY MAP**  
NOT TO SCALE



# **Attachment B**

## **Supporting Calc's, Rainfall Data & Manufacturer's Details**





**POINT PRECIPITATION FREQUENCY ESTIMATES**

Sanja Perica, Sarah Dietz, Sarah Heim, Lillian Hiner, Kazungu Maitaria, Deborah Martin, Sandra Pavlovic, Ishani Roy, Carl Trypaluk, Dale Unruh, Fenglin Yan, Michael Yekta, Tan Zhao, Geoffrey Bonnin, Daniel Brewer, Li-Chuan Chen, Tye Parzybok, John Yarchoan

NOAA, National Weather Service, Silver Spring, Maryland

[PF\\_tabular](#) | [PF\\_graphical](#) | [Maps\\_&\\_aerials](#)

**PF tabular**

PDS-based point precipitation frequency estimates with 90% confidence intervals (in inches) <sup>1</sup>										
Duration	Average recurrence interval (years)									
	1	2	5	10	25	50	100	200	500	1000
5-min	0.105 (0.087-0.127)	0.140 (0.117-0.171)	0.187 (0.155-0.228)	0.225 (0.185-0.277)	0.277 (0.220-0.352)	0.317 (0.246-0.412)	0.358 (0.271-0.477)	0.400 (0.295-0.549)	0.458 (0.323-0.656)	0.504 (0.343-0.747)
10-min	0.150 (0.125-0.182)	0.201 (0.167-0.245)	0.268 (0.222-0.327)	0.323 (0.265-0.397)	0.397 (0.315-0.505)	0.454 (0.353-0.591)	0.513 (0.389-0.684)	0.574 (0.422-0.787)	0.657 (0.464-0.940)	0.722 (0.492-1.07)
15-min	0.182 (0.151-0.220)	0.244 (0.202-0.296)	0.324 (0.269-0.396)	0.390 (0.321-0.480)	0.480 (0.381-0.611)	0.549 (0.427-0.714)	0.620 (0.470-0.827)	0.694 (0.511-0.951)	0.794 (0.561-1.14)	0.873 (0.595-1.30)
30-min	0.275 (0.229-0.334)	0.369 (0.306-0.448)	0.491 (0.407-0.599)	0.591 (0.485-0.726)	0.727 (0.577-0.924)	0.831 (0.646-1.08)	0.938 (0.711-1.25)	1.05 (0.773-1.44)	1.20 (0.848-1.72)	1.32 (0.901-1.96)
60-min	0.407 (0.339-0.494)	0.546 (0.454-0.664)	0.728 (0.603-0.887)	0.875 (0.719-1.08)	1.08 (0.855-1.37)	1.23 (0.957-1.60)	1.39 (1.05-1.85)	1.56 (1.15-2.13)	1.78 (1.26-2.55)	1.96 (1.34-2.90)
2-hr	0.581 (0.483-0.706)	0.758 (0.630-0.922)	0.989 (0.819-1.21)	1.18 (0.967-1.45)	1.43 (1.14-1.82)	1.63 (1.26-2.12)	1.83 (1.38-2.43)	2.03 (1.50-2.79)	2.31 (1.63-3.30)	2.52 (1.72-3.74)
3-hr	0.710 (0.590-0.862)	0.916 (0.761-1.11)	1.19 (0.982-1.45)	1.40 (1.15-1.73)	1.70 (1.35-2.16)	1.93 (1.50-2.51)	2.16 (1.64-2.88)	2.40 (1.77-3.29)	2.72 (1.92-3.89)	2.97 (2.02-4.40)
6-hr	0.983 (0.818-1.19)	1.26 (1.05-1.53)	1.62 (1.34-1.97)	1.91 (1.57-2.35)	2.31 (1.83-2.94)	2.61 (2.03-3.39)	2.92 (2.21-3.89)	3.24 (2.38-4.44)	3.67 (2.59-5.25)	4.00 (2.73-5.93)
12-hr	1.30 (1.08-1.58)	1.67 (1.39-2.03)	2.16 (1.79-2.63)	2.55 (2.10-3.14)	3.09 (2.45-3.93)	3.50 (2.72-4.55)	3.92 (2.97-5.23)	4.35 (3.21-5.97)	4.94 (3.48-7.07)	5.39 (3.67-7.99)
24-hr	1.77 (1.57-2.04)	2.30 (2.04-2.66)	3.01 (2.65-3.48)	3.58 (3.13-4.17)	4.36 (3.69-5.25)	4.96 (4.12-6.10)	5.58 (4.52-7.03)	6.21 (4.90-8.05)	7.08 (5.36-9.55)	7.76 (5.67-10.8)
2-day	2.18 (1.93-2.51)	2.88 (2.55-3.32)	3.81 (3.36-4.40)	4.57 (4.00-5.33)	5.62 (4.76-6.77)	6.44 (5.35-7.92)	7.28 (5.90-9.17)	8.16 (6.43-10.6)	9.37 (7.09-12.6)	10.3 (7.54-14.4)
3-day	2.37 (2.10-2.74)	3.17 (2.80-3.66)	4.23 (3.73-4.89)	5.11 (4.47-5.96)	6.33 (5.36-7.63)	7.29 (6.05-8.97)	8.28 (6.71-10.4)	9.31 (7.34-12.1)	10.7 (8.13-14.5)	11.9 (8.69-16.6)
4-day	2.54 (2.25-2.93)	3.42 (3.03-3.95)	4.60 (4.06-5.32)	5.58 (4.89-6.51)	6.95 (5.89-8.37)	8.03 (6.66-9.87)	9.14 (7.41-11.5)	10.3 (8.13-13.4)	11.9 (9.04-16.1)	13.2 (9.68-18.5)
7-day	2.89 (2.56-3.33)	3.97 (3.51-4.58)	5.42 (4.78-6.27)	6.63 (5.80-7.73)	8.33 (7.06-10.0)	9.67 (8.03-11.9)	11.1 (8.97-13.9)	12.6 (9.89-16.3)	14.6 (11.1-19.7)	16.3 (11.9-22.7)
10-day	3.13 (2.77-3.60)	4.34 (3.84-5.01)	5.98 (5.28-6.92)	7.36 (6.44-8.58)	9.28 (7.86-11.2)	10.8 (8.97-13.3)	12.4 (10.1-15.6)	14.1 (11.1-18.3)	16.5 (12.5-22.2)	18.4 (13.5-25.7)
20-day	3.87 (3.42-4.46)	5.44 (4.81-6.27)	7.57 (6.68-8.75)	9.36 (8.19-10.9)	11.9 (10.1-14.3)	13.9 (11.5-17.1)	16.0 (13.0-20.2)	18.3 (14.4-23.7)	21.5 (16.3-29.0)	24.1 (17.6-33.6)
30-day	4.55 (4.03-5.24)	6.38 (5.65-7.36)	8.88 (7.83-10.3)	11.0 (9.61-12.8)	14.0 (11.8-16.8)	16.4 (13.6-20.1)	18.9 (15.3-23.8)	21.6 (17.0-27.9)	25.4 (19.2-34.2)	28.4 (20.8-39.7)
45-day	5.48 (4.85-6.31)	7.58 (6.71-8.75)	10.5 (9.22-12.1)	12.9 (11.3-15.0)	16.3 (13.8-19.7)	19.1 (15.9-23.5)	22.1 (17.9-27.8)	25.2 (19.9-32.6)	29.7 (22.4-40.0)	33.3 (24.3-46.4)
60-day	6.46 (5.72-7.44)	8.79 (7.78-10.1)	12.0 (10.6-13.9)	14.7 (12.9-17.1)	18.6 (15.7-22.4)	21.7 (18.0-26.6)	24.9 (20.2-31.4)	28.5 (22.4-36.8)	33.5 (25.3-45.1)	37.6 (27.5-52.4)

<sup>1</sup> Precipitation frequency (PF) estimates in this table are based on frequency analysis of partial duration series (PDS). Numbers in parenthesis are PF estimates at lower and upper bounds of the 90% confidence interval. The probability that precipitation frequency estimates (for a given duration and average recurrence interval) will be greater than the upper bound (or less than the lower bound) is 5%. Estimates at upper bounds are not checked against probable maximum precipitation (PMP) estimates and may be higher than currently valid PMP values. Please refer to NOAA Atlas 14 document for more information.

[Back to Top](#)

**PF graphical**

For design assistance, drawings, and pricing send completed worksheet to:  
**dyods@contech-cpi.com**

**Project Summary**

Date:	1/21/2022
Project Name:	Oakmont - Tippecanoe
City / County:	Ontario
State:	California
Designed By:	D White
Company:	Huitt-Zollars, Inc.
Telephone:	909-941-7799

**Enter Information in Blue Cells**

**Corrugated Metal Pipe Calculator**

Storage Volume Required (cf):	60,192
Limiting Width (ft):	90.00
Invert Depth Below Asphalt (ft):	12.00
Solid or Perforated Pipe:	Perforated
Shape Or Diameter (in):	96
Number Of Headers:	2
Spacing between Barrels (ft):	3.00
Stone Width Around Perimeter of System (ft):	2
Depth A: Porous Stone Above Pipe (in):	6
Depth C: Porous Stone Below Pipe (in):	6
Stone Porosity (0 to 40%):	40

50.27 ft<sup>2</sup> Pipe Area

**System Sizing**

Pipe Storage:	43,932 cf
Porous Stone Storage:	17,030 cf
Total Storage Provided:	60,962 cf
Number of Barrels:	8 barrels
Length per Barrel:	88.0 ft
Length Per Header:	85.0 ft
Rectangular Footprint (W x L):	89. ft x 108. ft

101.3% Of Required Storage

**CONTECH Materials**

Total CMP Footage:	874 ft
Approximate Total Pieces:	40 pcs
Approximate Coupling Bands:	46 bands
Approximate Truckloads:	20 trucks

**Construction Quantities\*\***

Total Excavation:	4272 cy
Porous Stone Backfill For Storage:	1577 cy stone
Backfill to Grade Excluding Stone:	1068 cy fill

\*\*Construction quantities are approximate and should be verified upon final design

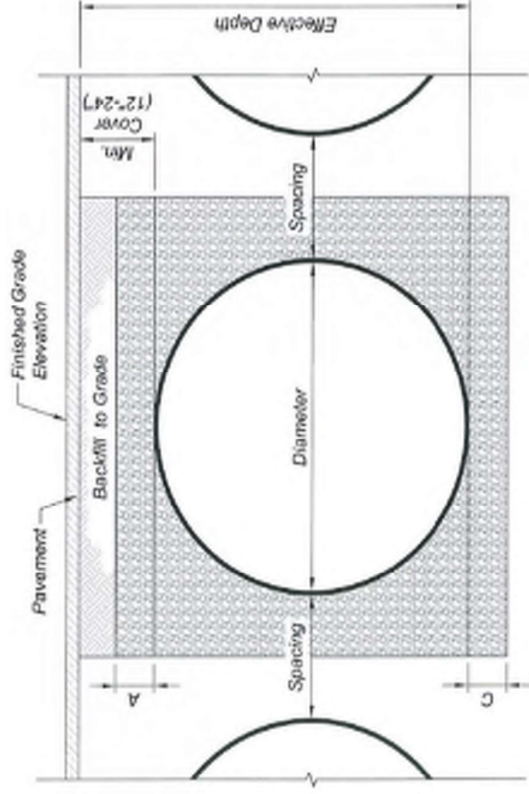
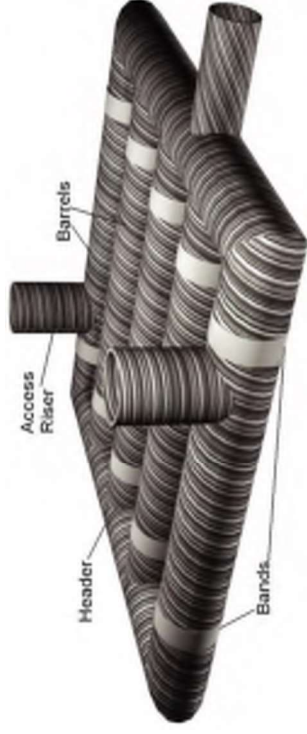

**System Layout**

Barrel 12	0
Barrel 11	0
Barrel 10	0
Barrel 9	0
Barrel 8	88
Barrel 7	88
Barrel 6	88
Barrel 5	88
Barrel 4	88
Barrel 3	88
Barrel 2	88
Barrel 1	88

Barrel Footage (w/o headers)

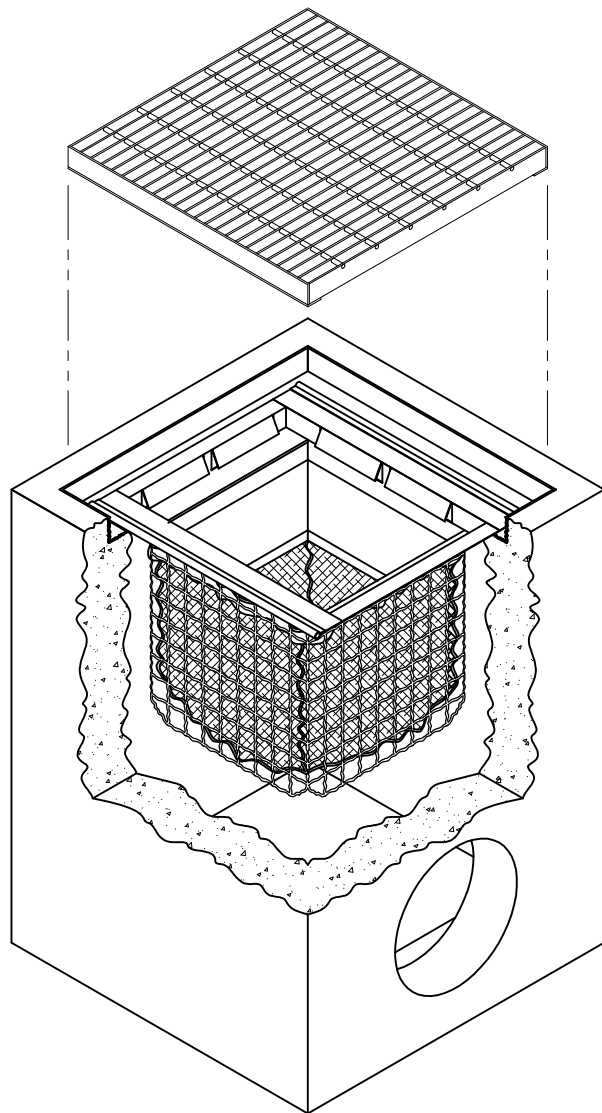

FloGard® FILTER  
-INSTALLED INTO CATCH BASIN-

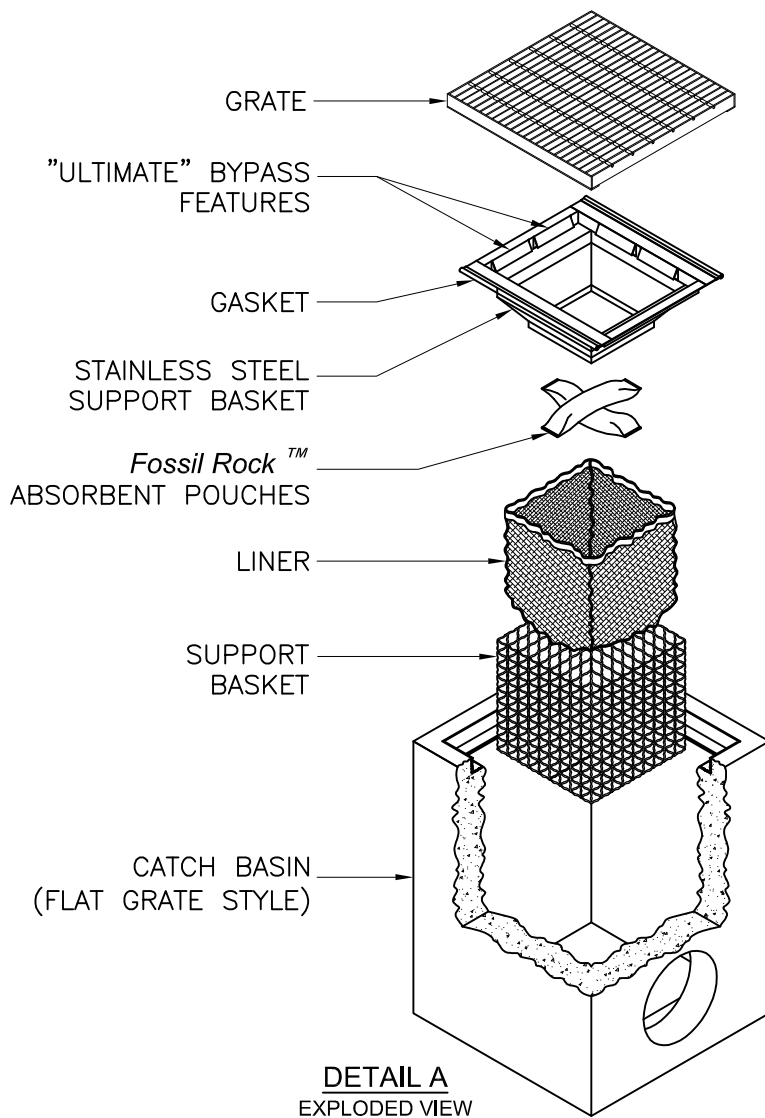

DETAIL A  
EXPLODED VIEW

NOTES:

1. Filter insert shall have a high flow bypass feature.
2. Filter support frame shall be constructed from stainless steel Type 304.
3. Filter medium shall be *Fossil Rock™*, installed and maintained in accordance with manufacturer specifications.
4. Storage capacity reflects 80% of maximum solids collection prior to impeding filtering bypass.

U.S. PATENT # 6,00,023 & 6,877,029



Inlet  
Filtration

**FloGard®**  
Catch Basin Insert Filter  
Grated Inlet Style



**Oldcastle®**  
Stormwater Solutions

7921 Southpark Plaza, Suite 200 | Littleton, CO | 80120 | Ph: 800.579.8819 | oldcastlestormwater.com  
THIS DOCUMENT IS THE PROPERTY OF OLDCASTLE PRECAST, INC. IT IS SUBMITTED FOR REFERENCE PURPOSES ONLY AND SHALL NOT BE USED IN ANY WAY INJURIOUS TO THE INTERESTS OF SAID COMPANY. COPYRIGHT © 2010 OLDCASTLE PRECAST, INC. ALL RIGHTS RESERVED.

DRAWING NO. FGP-0001	REV F	ECO ECO-0127	DATE JPR 5/18/15	DATE JPR 11/3/06	SHEET 1 OF 2
-------------------------	----------	-----------------	---------------------	---------------------	--------------

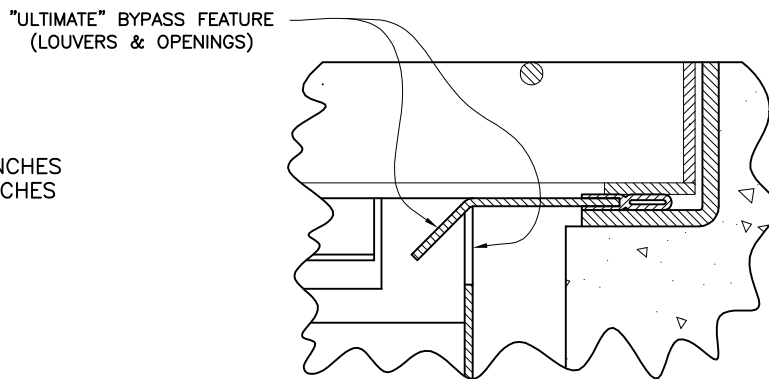
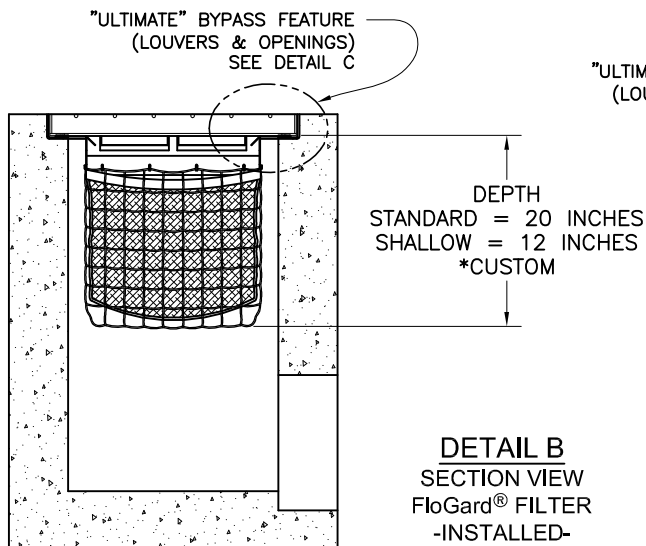

\* MANY OTHER STANDARD & CUSTOM SIZES & DEPTHS AVAILABLE UPON REQUEST.

SPECIFIER CHART								
MODEL NO.  STANDARD DEPTH	STANDARD & SHALLOW DEPTH (Data in these columns is the same for both STANDARD & SHALLOW versions)			STANDARD DEPTH -20 Inches-		MODEL NO.  SHALLOW DEPTH	SHALLOW DEPTH -12 Inches-	
	INLET ID Inside Dimension (inch x inch)	GRATE OD Outside Dimension (inch x inch)	TOTAL BYPASS CAPACITY (cu. ft. / sec.)	SOLIDS STORAGE CAPACITY (cu. ft.)	FILTERED FLOW (cu. ft. / sec.)		SOLIDS STORAGE CAPACITY (cu. ft.)	FILTERED FLOW (cu. ft. / sec.)
FGP-12F	12 X 12	12 X 14	2.8	0.3	0.4	FGP-12F8	.15	.25
FGP-1530F	15 X 30	15 X 35	6.9	2.3	1.6	FGP-1530F8	1.3	.9
FGP-16F	16 X 16	16 X 19	4.7	0.8	0.7	FGP-16F8	.45	.4
FGP-1624F	16 X 24	16 X 26	5.0	1.5	1.2	FGP-1624F8	.85	.7
FGP-18F	18 X 18	18 X 20	4.7	0.8	0.7	FGP-18F8	.45	.4
FGP-1820F	16 X 19	18 X 21	5.9	2.1	1.4	FGP-1820F8	1.2	.8
FGP-1824F	16 X 22	18 X 24	5.0	1.5	1.2	FGP-1824F8	.85	.7
FGP-1836F	18 X 36	18 X 40	6.9	2.3	1.6	FGP-1836F8	1.3	.9
FGP-2024F	18 X 22	20 X 24	5.9	1.2	1.0	FGP-2024F8	.7	.55
FGP-21F	22 X 22	22 X 24	6.1	2.2	1.5	FGP-21F8	1.25	.85
FGP-2142F	21 X 40	24 X 40	9.1	4.3	2.4	FGP-2142F8	2.45	1.35
FGP-2148F	19 X 46	22 X 48	9.8	4.7	2.6	FGP-2148F8	2.7	1.5
FGP-24F	24 X 24	24 X 27	6.1	2.2	1.5	FGP-24F8	1.25	.85
FGP-2430F	24 X 30	26 X 30	7.0	2.8	1.8	FGP-2430F8	1.6	1.05
FGP-2436F	24 X 36	24 X 40	8.0	3.4	2.0	FGP-2436F8	1.95	1.15
FGP-2448F	24 X 48	26 X 48	9.3	4.4	2.4	FGP-2448F8	2.5	1.35
FGP-28F	28 X 28	32 X 32	6.3	2.2	1.5	FGP-28F8	1.25	.85
FGP-2440F	24 X 36	28 X 40	8.3	4.2	2.3	FGP-2440F8	2.4	1.3
FGP-30F	30 X 30	30 X 34	8.1	3.6	2.0	FGP-30F8	2.05	1.15
FGP-36F	36 X 36	36 X 40	9.1	4.6	2.4	FGP-36F8	2.65	1.35
FGP-3648F	36 X 48	40 X 48	11.5	6.8	3.2	FGP-3648F8	3.9	1.85
FGP-48F	48 X 48	48 X 54	13.2	9.5	3.9	FGP-48F8	5.45	2.25
FGP-SD24F	24 X 24	28 X 28	6.1	2.2	1.5	FGP-SD24F8	1.25	.85



**FloGard®**  
*Catch Basin Insert Filter*  
*Grated Inlet Style*



**Oldcastle®**  
 Stormwater Solutions

7921 Southpark Plaza, Suite 200 | Littleton, CO | 80120 | Ph: 800.579.8819 | oldcastlestormwater.com  
 THIS DOCUMENT IS THE PROPERTY OF OLDCASTLE PRECAST, INC. IT IS SUBMITTED FOR REFERENCE PURPOSES ONLY AND SHALL NOT BE USED IN ANY WAY INJURIOUS TO THE INTERESTS OF SAID COMPANY. COPYRIGHT © 2010 OLDCASTLE PRECAST, INC. ALL RIGHTS RESERVED.

DRAWING NO. FGP-0001	REV F	ECO ECO-0127	DATE JPR 5/18/15	DATE JPR 11/3/06	SHEET 2 OF 2
-------------------------	----------	-----------------	---------------------	---------------------	--------------

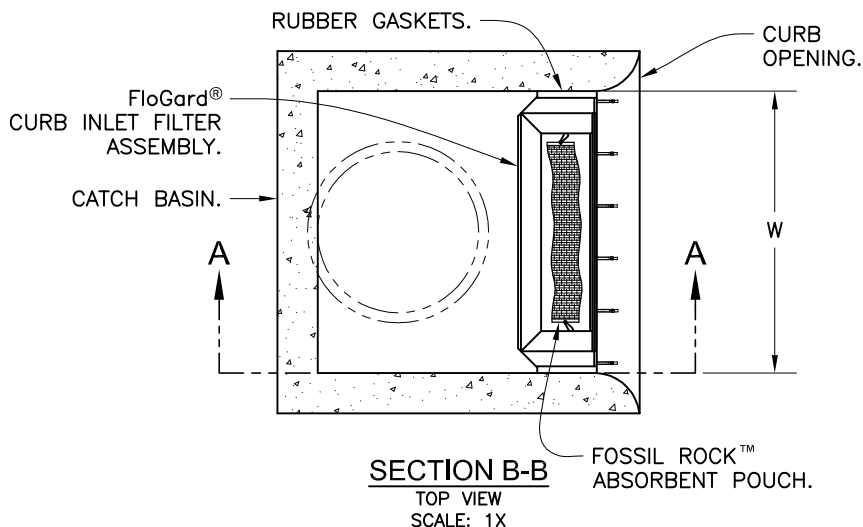
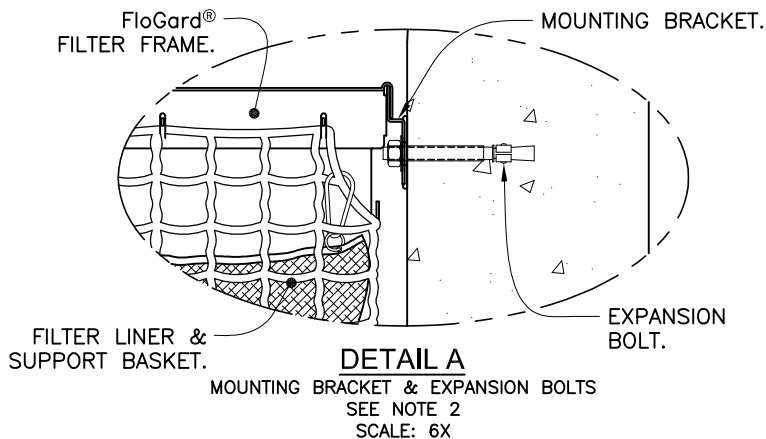

SPECIFIER CHART				
MODEL NO.	Curb Opening Width - W -	Storage Capacity - Cu. Ft. -	Filtered Flow Rate - GPM/CFS -	Bypass Flow Rate - GPM/CFS -
FGP-24CI	2.0' (24")	.95	338 / .75	2,513 / 5.6
FGP-30CI	2.5' (30")	1.20	450 / 1.00	3,008 / 6.7
FGP-36CI	3.0' (36")	1.50	563 / 1.25	3,547 / 7.9
FGP-42CI	3.5' (42")	1.80	675 / 1.50	3,951 / 8.8
FGP-48CI	4.0' (48")	2.10	768 / 1.76	4,445 / 9.9
FGP-5.0CI	5.0' (60")	2.40	900 / 2.00	5,208 / 11.6
FGP-6.0CI	6.0' (72")	3.05	1,126 / 2.51	6,196 / 13.8
FGP-7.0CI	7.0' (84")	3.65	1,350 / 3.01	7,139 / 15.9
FGP-8.0CI	8.0' (96")	4.25	1,576 / 3.51	8,082 / 18.0
FGP-10.0CI	10.0' (120")	4.85	1,800 / 4.01	9,833 / 21.9
FGP-12.0CI	12.0' (144")	6.10	2,252 / 5.02	11,764 / 26.2
FGP-14.0CI	14.0' (168")	7.30	2,700 / 6.02	13,515 / 30.1
FGP-16.0CI	16.0' (192")	8.55	3,152 / 7.02	15,446 / 34.4
FGP-18.0CI	18.0' (216")	9.45	3,490 / 7.78	17,152 / 38.2
FGP-21.0CI	21.0' (252")	10.95	4,050 / 9.02	19,891 / 44.3
FGP-28.0CI	28.0' (336")	14.60	5,400 / 12.03	26,311 / 58.6

NOTES:

1. Filter insert shall have a high flow bypass feature.
2. Filter support frame shall be constructed from stainless steel Type 304.
3. Filter medium shall be *Fossil Rock™*, installed and maintained in accordance with manufacturer specifications.
4. Storage capacity reflects 80% of maximum solids collection prior to impeding filtering bypass.

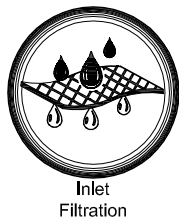
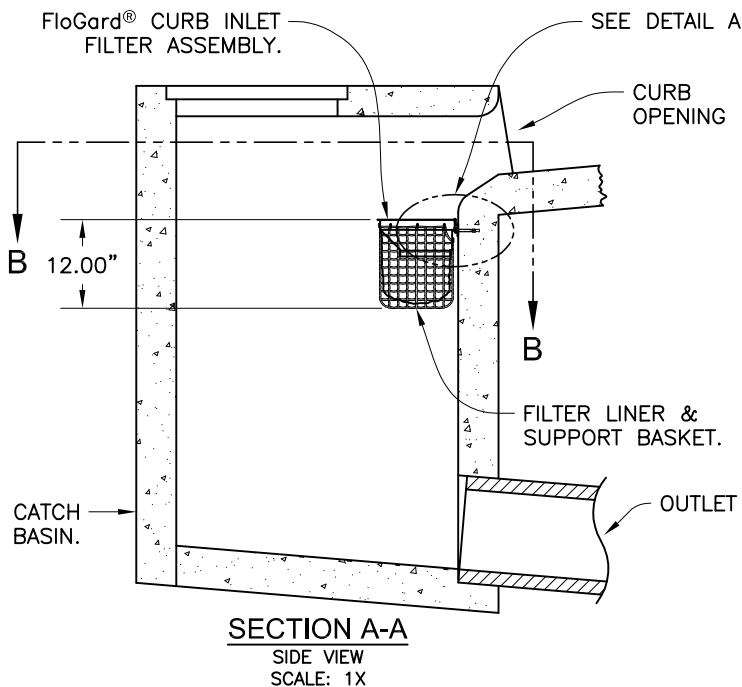

**FloGard®**  
 Catch Basin Insert Filter  
 Curb Inlet Style



**Oldcastle®**  
 Stormwater Solutions

7921 Southpark Plaza, Suite 200 | Littleton, CO | 80120 | Ph: 800.579.8819 | oldcastlestormwater.com  
 THIS DOCUMENT IS THE PROPERTY OF OLDCASTLE PRECAST, INC. IT IS SUBMITTED FOR REFERENCE PURPOSES ONLY AND SHALL NOT BE USED IN ANY WAY INJURIOUS TO THE INTERESTS OF SAID COMPANY. COPYRIGHT © 2010 OLDCASTLE PRECAST, INC. ALL RIGHTS RESERVED.

DRAWING NO. FGP-0002	REV E	ECO ECO-0127 JPR 5/18/15	DATE JPR 1/3/06	SHEET 1 OF 1
-------------------------	----------	--------------------------------	--------------------	--------------

# **Attachment C**

## **Educational Materials**



# The Updated Model Water Efficient Landscape Ordinance

C A L I F O R N I A   D E P A R T M E N T   O F   W A T E R   R E S O U R C E S

Landscapes are essential to the quality of life in California. They provide areas for recreation, enhance the environment, clean the air and water, prevent erosion, offer fire protection and replace ecosystems lost to development.

California's economic prosperity and environmental quality are dependant on an adequate supply of water for beneficial uses. In California, about half of the urban water used is for landscape irrigation. Ensuring **efficient landscapes** in new developments and reducing water waste in existing landscapes are the most cost-effective ways to stretch our limited water supplies and ensure that we continue to have sufficient water for California to prosper.

The Water Conservation in Landscaping Act of 2006 (Assembly Bill 1881, Laird) requires cities, counties, and charter cities and charter counties, to adopt landscape water conservation ordinances by January 1, 2010. Pursuant to this law, the Department of Water Resources (DWR) has prepared a Model Water Efficient Landscape Ordinance (Model Ordinance) for use by local agencies. The Model Ordinance was approved by the Office of Administrative Law on September 10, 2009. The Model Ordinance became effective on September 10.

All local agencies must adopt a water efficient landscape ordinance by **January 1, 2010**. The local agencies may adopt the state Model Ordinance, or craft an ordinance to fit local conditions. In addition, several local agencies may collaborate and craft a region-wide ordinance. In any case, the adopted ordinance must be as effective as the Model Ordinance in regard to water conservation.

For more information, please visit our web site at <http://www.water.ca.gov/wateruseefficiency/landscapeordinance/>





## Important points to consider...

### **Water purveyors have an important role.**

The enabling statute was directed to local agencies that make land use decisions and approve land development. Active participation by water purveyors can make the implementation, enforcement and follow-up actions of an ordinance more effective.

Most new and rehabilitated landscapes are subject to a water efficient landscape ordinance. Public landscapes and private development projects including developer installed single family and multi-family residential landscapes with at least 2500 sq. ft. of landscape area are subject to the Model Ordinance .

Homeowner provided landscaping at single family and multi-family homes are subject to the Model Ordinance if the landscape area is at least 5000 sq. ft

### **Existing landscapes are also subject to the Model Ordinance.**

Water waste is common in landscapes that are poorly designed or not well maintained. Water waste (from runoff, overspray, low head drainage, leaks and excessive amounts of applied irrigation water in landscapes is prohibited by Section 2, Article X of the California Constitution.

Any landscape installed prior to January 1, 2010, that is at least one acre in size may be subject to irrigation audits, irrigation surveys or water use analysis programs for evaluating irrigation system performance and adherence to the Maximum Applied Water Allowance as defined in the 1992 Model Ordinance with an Evapotranspiration Adjustment Factor (ETAF) of 0.8. Local agencies and water purveyors (designated by the local agency) may institute these or other programs to increase efficiency in existing landscapes.

### **All new landscapes will be assigned a water budget.**

The water budget approach is a provision in the statute that ensures a landscape is allowed sufficient water. There are two water budgets in the Model Ordinance; the Maximum Applied Water Allowance (MAWA) and the Estimated Total Water Use (ETWU).

The MAWA, is the water budget used for compliance and is an annual water allowance based on landscape area, local evapotranspiration and ETAF of 0.7. The ETWU is an annual water use estimation for design purposes and is based on the water needs of the plants actually chosen for a given landscape. The ETWU may not exceed the MAWA.

### **Water efficient landscapes offer multiple benefits.**

Water efficient landscapes will stretch our limited water supplies. Other benefits include reduced irrigation runoff, reduced pollution of waterways, less property damage, less green waste, increased drought resistance and a smaller carbon footprint.

### **The Department of Water Resources will offer technical assistance.**

The Department plans to offer a series of workshops, publications and other assistance for successful adoption and implementation of the Model Ordinance or local water efficient landscape ordinances. Information regarding these resources may be found on the DWR website: <http://www.water.ca.gov/wateruseefficiency/landscapeordinance/> Questions on the Model Ordinance may be sent by e-mail to DWR staff at: [mweo@water.ca.gov](mailto:mweo@water.ca.gov).



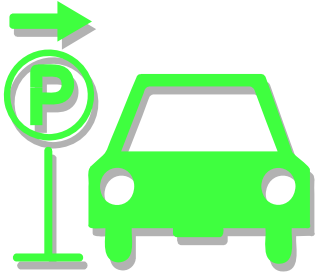

## R-3 AUTOMOBILE PARKING

Parked automobiles may contribute pollutants to the storm drain because poorly maintained vehicles may leak fluids containing hydrocarbons, metals, and other pollutants. In addition, heavily soiled automobiles may drop clods of dirt onto the parking surface, contributing to the sediment load when runoff is present. During rain events, or wash-down activities, the pollutants may be carried into the storm drain system. The pollution prevention activities outlined in this fact sheets are used to prevent the discharge of pollutants to the storm drain system.

The activities outlined in this fact sheet target the following pollutants:	
Sediment	x
Nutrients	
Bacteria	
Foaming Agents	
Metals	X
Hydrocarbons	X
Hazardous Materials	x
Pesticides and Herbicides	
Other	

Think before parking your car. Remember - The ocean starts at your front door.

### Required Activities

- If required, vehicles have to be removed from the street during designated street sweeping/cleaning times.
- If the automobile is leaking, place a pan or similar collection device under the automobile, until such time as the leak may be repaired.
- Use dry cleaning methods to remove any materials deposited by vehicles (e.g. adsorbents for fluid leaks, sweeping for soil clod deposits).

### Recommended Activities

- Park automobiles over permeable surfaces (e.g. gravel, or porous cement).
- Limit vehicle parking to covered areas.
- Perform routine maintenance to minimize fluid leaks, and maximize fuel efficiency.

#### For additional information contact:

County of Orange, **OC Watershed**

Main: (714) 955-0600/ 24hr Water Pollution Discharge Hotline 1-877-89-SPILL

or visit our website at: [www.ocwatersheds.com](http://www.ocwatersheds.com)



## R-8 WATER CONSERVATION

Excessive irrigation and/or the overuse of water is often the most significant factor in transporting pollutants to the storm drain system. Pollutants from a wide variety of sources including automobile repair and maintenance, automobile washing, automobile parking, home and garden care activities and pet care may dissolve in the water and be transported to the storm drain. In addition, particles and materials coated with fertilizers and pesticides may be suspended in the flow and be transported to the storm drain.

The activities outlined in this fact sheet target the following pollutants:	
Sediment	x
Nutrients	x
Bacteria	x
Foaming Agents	x
Metals	x
Hydrocarbons	x
Hazardous Materials	x
Pesticides and Herbicides	x
Other	x

Hosing off outside areas to wash them down not only consumes large quantities of water, but also transports any pollutants, sediments, and waste to the storm drain system. The pollution prevention activities outlined in this fact sheets are used to prevent the discharge of pollutants to the storm drain system.

Think before using water. Remember - The ocean starts at your front door.

### Required Activities

- Irrigation systems must be properly adjusted to reflect seasonal water needs.
- Do not hose off outside surfaces to clean, sweep with a broom instead.

### Recommended Activities

- Fix any leaking faucets and eliminate unnecessary water sources.
- Use xeriscaping and drought tolerant landscaping to reduce the watering needs.
- Do not over watering lawns or gardens. Over watering wastes water and promotes diseases.
- Use a bucket to re-soak sponges/rags while washing automobiles and other items outdoors. Use hose only for rinsing.
- Wash automobiles at a commercial car wash employing water recycling.

### For additional information contact:

County of Orange, **OC Watershed**

Main: (714) 955-0600/ 24hr Water Pollution Discharge Hotline 1-877-89-SPILL

or visit our website at: [www.ocwatersheds.com](http://www.ocwatersheds.com)

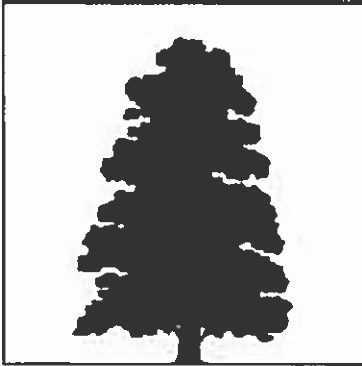

## **LANDSCAPE MAINTENANCE**

**The model procedures described below focus on minimizing the discharge of pesticides and fertilizers, landscape waste, trash, debris, and other pollutants to the storm drain system and receiving waters. Landscape maintenance practices may involve one or more of the following activities:**

- 1. Mowing, Trimming/Weeding, and Planting**
- 2. Irrigation**
- 3. Fertilizer and Pesticide Management**
- 4. Managing Landscape Waste**
- 5. Erosion Control**

### **POLLUTION PREVENTION:**

Pollution prevention measures have been considered and incorporated in the model procedures. Implementation of these measures may be more effective and reduce or eliminate the need to implement other more complicated or costly procedures. Possible pollution prevention measures for landscape maintenance include:

- Implement an integrated pest management (IPM) program. IPM is a sustainable approach to managing pests by combining biological, cultural, physical, and chemical tools. Refer to Appendix D, Fertilizer and Pesticide Management Guidance for further details.
- Choose low water using flowers, trees, shrubs, and groundcover.
- Appropriate maintenance (i.e. properly timed fertilizing, weeding, pest control, and pruning) will preserve the landscapes water efficiency.
- Once per year, educate municipal staff on pollution prevention measures.

### **MODEL PROCEDURES:**

#### **1. Mowing, Trimming/Weeding, and Planting**

##### **Mowing, Trimming/Weeding**

- ✓ Whenever possible, use mechanical methods of vegetation removal rather than applying herbicides. Use hand weeding where practical.

- ✓ When conducting mechanical or manual weed control, avoid loosening the soil, which could erode into streams or storm drains.
- ✓ Use coarse textured mulches or geotextiles to suppress weed growth and reduce the use of herbicides.
- ✓ Do not blow or rake leaves, etc. into the street or place yard waste in gutters or on dirt shoulders. Sweep up any leaves, litter or residue in gutters or on street.
- ✓ Collect lawn and garden clippings, pruning waste, tree trimmings, and weeds. Chip if necessary, and compost or dispose of at a landfill (see waste management section of this procedure sheet).
- ✓ Place temporarily stockpiled material away from watercourses, and berm or cover stockpiles to prevent material releases to storm drains.

## Planting

- ✓ Where feasible, retain and/or plant selected native vegetation whose features are determined to be beneficial. Native vegetation usually requires less maintenance (e.g., irrigation, fertilizer) than planting ornamental vegetation.
- ✓ When planting or replanting consider using low water use groundcovers.

### OPTIONAL:

- Careful soil mixing and layering techniques using a topsoil mix or composted organic material can be used as an effective measure to reduce herbicide use and watering.

## 2. Irrigation

- ✓ Utilize water delivery rates that do not exceed the infiltration rate of the soil.
- ✓ Use timers appropriately or a drip system to prevent runoff and then only irrigate as much as is needed.
- ✓ Inspect irrigation system periodically to ensure that the right amount of water is being applied and that excessive runoff is not occurring. Minimize excess watering, and repair leaks in the irrigation system as soon as they are observed.
- ✓ Where practical, use automatic timers to minimize runoff.
- ✓ Use popup sprinkler heads in areas with a lot of activity or where there is a chance the pipes may be broken. Consider the use of mechanisms that reduce water flow to sprinkler heads if broken.
- ✓ If re-claimed water is used for irrigation, ensure that there is no runoff from the landscaped area(s).
- ✓ If bailing of muddy water is required (e.g. when repairing a water line leak), do not put it in the storm drain; pour over landscaped areas.

## 3. Fertilizer and Pesticide Management

### Usage

- ✓ Utilize a comprehensive management system that incorporates integrated pest management techniques.
- ✓ Follow all federal, state, and local laws and regulations governing the use, storage, and disposal of fertilizers and pesticides and training of applicators and pest control advisors.
- ✓ Educate and train employees on use of pesticides and in pesticide application techniques to prevent pollution.
- ✓ Pesticide application must be under the supervision of a California qualified pesticide applicator.
- ✓ When applicable use the least toxic pesticides that will do the job. Avoid use of copper-based pesticides if possible.
- ✓ Do not mix or prepare pesticides or fertilizers for application near storm drains.
- ✓ Prepare the minimum amount of pesticide needed for the job and use the lowest rate that will effectively control the pest.
- ✓ Employ techniques to minimize off-target application (e.g. spray drift) of pesticides, including consideration of alternative application techniques.
- ✓ Calibrate fertilizer and pesticide application equipment to avoid excessive application.
- ✓ Periodically test soils for determining proper fertilizer use.
- ✓ Sweep pavement and sidewalk if fertilizer is spilled on these surfaces before applying irrigation water.
- ✓ Inspect pesticide/fertilizer equipment and transportation vehicles daily.
- ✓ Refer to Appendix D for further guidance on Fertilizer and Pesticide management

#### OPTIONAL:

- Work fertilizers into the soil rather than dumping or broadcasting them onto the surface.
- Use beneficial insects where possible to control pests (green lacewings, ladybugs, praying mantis, ground beetles, parasitic nematodes, trichogramma wasps, seedhead weevils, and spiders prey on detrimental pest species).
- Use slow release fertilizers whenever possible to minimize leaching.

### Scheduling

- ✓ Do not use pesticides if rain is expected within 24 hours.
- ✓ Apply pesticides only when wind speeds are low (less than 5 mph).

## Disposal

- ✓ Purchase only the amount of pesticide that you can reasonably use in a given time period (month or year depending on the product).
- ✓ Triple rinse containers, and use rinse water as product. Dispose of unused pesticide as hazardous waste.
- ✓ Dispose of empty pesticide containers according to the instructions on the container label.

## 4. Managing Landscape Waste

*Also see Waste Handling and Disposal procedure sheet*

- ✓ Compost leaves, sticks, or other collected vegetation or dispose of at a permitted landfill. Do not dispose of collected vegetation into waterways or storm drainage systems.
- ✓ Place temporarily stockpiled material away from watercourses and storm drain inlets, and berm or cover stockpiles to prevent material releases to the storm drain system.
- ✓ Reduce the use of high nitrogen fertilizers that produce excess growth requiring more frequent mowing or trimming.
- ✓ Inspection of drainage facilities should be conducted to detect illegal dumping of clippings/cuttings in or near these facilities. Materials found should be picked up and properly disposed of.
- ✓ Landscape wastes in and around storm drain inlets should be avoided by either using bagging equipment or by manually picking up the material.

## 5. Erosion Control

*Also see Waste Handling and Disposal procedure sheet*

- ✓ Maintain vegetative cover on medians and embankments to prevent soil erosion. Apply mulch or leave clippings to serve as additional cover for soil stabilization and to reduce the velocity of storm water runoff.
- ✓ Minimize the use of disking as a means of vegetation management because the practice may result in erodable barren soil.
- ✓ Confine excavated materials to pervious surfaces away from storm drain inlets, sidewalks, pavement, and ditches. Material must be covered if rain is expected.

---

### LIMITATIONS:

Alternative pest/weed controls may not be available, suitable, or effective in every case.

## REFERENCES:

*California Storm Water Best Management Practice Handbooks. Industrial/Commercial Best Management Practice Handbook. Prepared by Camp Dresser & McKee, Larry Walker Associates, Uribe and Associates, Resources Planning Associates for Stormwater Quality Task Force. July 1993.*

County of Orange. 2000. Public Facilities and Resources Department, Management Guidelines for the Use of Fertilizers and Pesticides. September.

King County Stormwater Pollution Control Manual. Best Management Practices for Businesses. 1995. King County Surface Water Management. July. On-line: <http://dnr.metrokc.gov/wlr/dss/spcm.htm>

Los Angeles County Stormwater Quality Model Programs. Public Agency Activities  
[http://ladpw.org/wmd/npdes/model\\_links.cfm](http://ladpw.org/wmd/npdes/model_links.cfm)

Model Urban Runoff Program: A How-To Guide for Developing Urban Runoff Programs for Small Municipalities. Prepared by City of Monterey, City of Santa Cruz, California Coastal Commission, Monterey Bay National Marine Sanctuary, Association of Monterey Bay Area Governments, Woodward-Clyde, Central Coast Regional Water Quality Control Board. July. 1998.

Santa Clara Valley Urban Runoff Pollution Prevention Program. 1997 Urban Runoff Management Plan. September 1997, updated October 2000.

## IC7. LANDSCAPE MAINTENANCE

### Best Management Practices (BMPs)

A BMP is a technique, measure or structural control that is used for a given set of conditions to improve the quality of the stormwater runoff in a cost effective manner<sup>1</sup>. The minimum required BMPs for this activity are outlined in the box to the right. Implementation of pollution prevention/good housekeeping measures may reduce or eliminate the need to implement other more costly or complicated procedures. Proper employee training is key to the success of BMP implementation.

The BMPs outlined in this fact sheet target the following pollutants:

Targeted Constituents	
Sediment	x
Nutrients	x
Floatable Materials	x
Metals	
Bacteria	x
Oil & Grease	
Organics & Toxicants	
Pesticides	x
Oxygen Demanding	x

#### MINIMUM BEST MANAGEMENT PRACTICES Pollution Prevention/Good Housekeeping

- Properly store and dispose of gardening wastes.
- Use mulch or other erosion control measures on exposed soils.
- Properly manage irrigation and runoff.
- Properly store and dispose of chemicals.
- Properly manage pesticide and herbicide use.
- Properly manage fertilizer use.

#### Stencil storm drains

#### Training

- Train employees on these BMPs, storm water discharge prohibitions, and wastewater discharge requirements.
- Provide on-going employee training in pollution prevention.

Provided below are specific procedures associated with each of the minimum BMPs along with procedures for additional BMPs that should be considered if this activity takes place at a facility located near a sensitive waterbody. In order to meet the requirements for medium and high priority facilities, the owners/operators must select, install and maintain appropriate BMPs on site. Since the selection of the appropriate BMPs is a site-specific process, the types and numbers of additional BMPs will vary for each facility.

#### 1. Take steps to reduce landscape maintenance requirements.

- Where feasible, retain and/or plant native vegetation with features that are determined to be beneficial. Native vegetation usually requires less maintenance than planting new vegetation.
- When planting or replanting consider using low water use flowers, trees, shrubs, and groundcovers.
- Consider alternative landscaping techniques such as naturescaping and xeriscaping.

#### 2. Properly store and dispose of gardening wastes.

- Dispose of grass clippings, leaves, sticks, or other collected vegetation as garbage at a permitted landfill or by composting.
- Do not dispose of gardening wastes in streets, waterways, or storm drainage systems.
- Place temporarily stockpiled material away from watercourses and storm drain inlets, and berm and/or cover.

#### 3. Use mulch or other erosion control measures on exposed soils.

<sup>1</sup> EPA " Preliminary Data Summary of Urban Stormwater Best Management Practices"



4. **Properly manage irrigation and runoff.**
  - Irrigate slowly or pulse irrigate so the infiltration rate of the soil is not exceeded.
  - Inspect irrigation system regularly for leaks and to ensure that excessive runoff is not occurring.
  - If re-claimed water is used for irrigation, ensure that there is no runoff from the landscaped area(s).
  - If bailing of muddy water is required (e.g. when repairing a water line leak), do not put it in the storm drain; pour over landscaped areas.
  - Use automatic timers to minimize runoff.
  - Use popup sprinkler heads in areas with a lot of activity or where pipes may be broken. Consider the use of mechanisms that reduce water flow to broken sprinkler heads.
5. **Properly store and dispose of chemicals.**
  - Implement storage requirements for pesticide products with guidance from the local fire department and/or County Agricultural Commissioner.
  - Provide secondary containment for chemical storage.
  - Dispose of empty containers according to the instructions on the container label.
  - Triple rinse containers and use rinse water as product.
6. **Properly manage pesticide and herbicide use.**
  - Follow all federal, state, and local laws and regulations governing the use, storage, and disposal of pesticides and herbicides and training of applicators and pest control advisors.
  - Follow manufacturers' recommendations and label directions.
  - Use pesticides only if there is an actual pest problem (not on a regular preventative schedule). When applicable use less toxic pesticides that will do the job. Avoid use of copper-based pesticides if possible. Use the minimum amount of chemicals needed for the job.
  - Do not apply pesticides if rain is expected or if wind speeds are above 5 mph.
  - Do not mix or prepare pesticides for application near storm drains. Prepare the minimum amount of pesticide needed for the job and use the lowest rate that will effectively control the targeted pest.
  - Whenever possible, use mechanical methods of vegetation removal rather than applying herbicides. Use hand weeding where practical.
  - Do not apply any chemicals directly to surface waters, unless the application is approved and permitted by the state. Do not spray pesticides within 100 feet of open waters.
  - Employ techniques to minimize off-target application (e.g. spray drift) of pesticides, including consideration of alternative application techniques.
  - When conducting mechanical or manual weed control, avoid loosening the soil, which could lead to erosion.
  - Purchase only the amount of pesticide that you can reasonably use in a given time period.
  - Careful soil mixing and layering techniques using a topsoil mix or composted organic material can be used as an effective measure to reduce herbicide use and watering.
7. **Properly manage fertilizer use.**
  - Follow all federal, state, and local laws and regulations governing the use, storage, and disposal of fertilizers.
  - Follow manufacturers' recommendations and label directions.
  - Employ techniques to minimize off-target application (e.g. spray drift) of fertilizer, including consideration of alternative application techniques. Calibrate fertilizer distributors to avoid excessive application.
  - Periodically test soils for determining proper fertilizer use.
  - Fertilizers should be worked into the soil rather than dumped or broadcast onto the surface.
  - Sweep pavement and sidewalk if fertilizer is spilled on these surfaces before applying irrigation water.
  - Use slow release fertilizers whenever possible to minimize leaching
  -

**8. Incorporate the following integrated pest management techniques where appropriate:**

- Mulching can be used to prevent weeds where turf is absent.
- Remove insects by hand and place in soapy water or vegetable oil. Alternatively, remove insects with water or vacuum them off the plants.
- Use species-specific traps (e.g. pheromone-based traps or colored sticky cards).
- Sprinkle the ground surface with abrasive diatomaceous earth to prevent infestations by soft-bodied insects and slugs. Slugs also can be trapped in small cups filled with beer that are set in the ground so the slugs can get in easily.
- In cases where microscopic parasites, such as bacteria and fungi, are causing damage to plants, the affected plant material can be removed and disposed of (pruning equipment should be disinfected with bleach to prevent spreading the disease organism).
- Small mammals and birds can be excluded using fences, netting, and tree trunk guards.
- Promote beneficial organisms, such as bats, birds, green lacewings, ladybugs, praying mantis, ground beetles, parasitic nematodes, trichogramma wasps, seedhead weevils, and spiders that prey on detrimental pest species.

**Training**

1. **Train employees on these BMPs, storm water discharge prohibitions, and wastewater discharge requirements.**
2. **Educate and train employees on the use of pesticides and pesticide application techniques. Only employees properly trained to use pesticides can apply them.**
3. **Train and encourage employees to use integrated pest management techniques.**
4. **Train employees on proper spill containment and cleanup.**
  - Establish training that provides employees with the proper tools and knowledge to immediately begin cleaning up a spill.
  - Ensure that employees are familiar with the site's spill control plan and/or proper spill cleanup procedures.
  - BMP IC17 discusses Spill Prevention and Control in detail.
5. **Establish a regular training schedule, train all new employees, and conduct annual refresher training.**
6. **Use a training log or similar method to document training.**

**Stencil storm drains**

Storm drain system signs act as highly visible source controls that are typically stenciled directly adjacent to storm drain inlets. Stencils should read "No Dumping Drains to Ocean".

**References**

California Storm Water Best Management Practice Handbook. Industrial and Commercial. 2003. [www.cabmphandbooks.com](http://www.cabmphandbooks.com)

California Storm Water Best Management Practice Handbooks. Industrial/Commercial Best Management Practice Handbook. Prepared by Camp Dresser & McKee, Larry Walker Associates, Uribe and Associates, Resources Planning Associates for Stormwater Quality Task Force. March 1993.

King County Stormwater Pollution Control Manual. Best Management Practices for Businesses. King County Surface Water Management. July 1995. On-line: <http://dnr.metrokc.gov/wlr/dss/spcm.htm>

Stormwater Management Manual for Western Washington. Volume IV Source Control BMPs. Prepared by Washington State Department of Ecology Water Quality Program. Publication No. 99-14. August 2001.

Water Quality Handbook for Nurseries. Oklahoma Cooperative Extension Service. Division of Agricultural Sciences and Natural Resources. Oklahoma State University. E-951. September 1999.

**For additional information contact:**

County of Orange  
Watershed & Coastal Resources  
Stormwater Program  
(714)567-6363  
or visit our website at:  
[www.ocwatersheds.com](http://www.ocwatersheds.com)

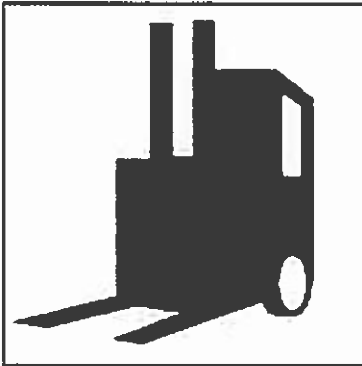

**FF-6**

## **MATERIAL LOADING AND UNLOADING**

**The loading/unloading of materials usually takes place outside; therefore, materials spilled, leaked, or lost during loading/unloading have the potential to collect in the soil or on other surfaces and be carried away by runoff or when the area is cleaned. Additionally, rainfall may wash pollutants from machinery used to unload or move materials. Material loading and unloading involves the following activities:**

### **POLLUTION PREVENTION:**

Pollution prevention measures have been considered and incorporated in the model procedures. Implementation of these measures may be more effective and reduce or eliminate the need to implement other more complicated or costly procedures. Possible pollution prevention measures for material loading and unloading include:

- Check loading and unloading equipment regularly for leaks.
- Cover loading docks.
- Once per year, educate municipal staff on pollution prevention measures.

### **MODEL PROCEDURES:**

#### **General Guidelines**

- ✓ Regularly clean work areas to remove materials such as debris, sandblasting material, etc.
- ✓ Design loading/unloading area to prevent stormwater runoff that would include grading or berming the area, and positioning roof downspouts so they direct stormwater away from loading/unloading areas.
- ✓ Use overhangs or door skirts that enclose the trailer.
- ✓ Park tank trucks or delivery vehicles so that spills or leaks can be contained.
- ✓ Avoid loading and exposing materials during rain events unless the loading dock is covered and protected from rain. A seal or door skirt between the trailer and the building may also prevent exposure to rain.
- ✓ Shipboard cooling and process water discharges should be directed to minimize contact with spent abrasives, paint, and other debris.

## Tank truck transfers

- ✓ The area where the transfer takes place should be paved. If the liquid is reactive with the asphalt, Portland cement should be used to pave the area.
- ✓ Transfer area should be designed to prevent runoff of stormwater from adjacent areas. Sloping the pad and using a berm around the uphill side of the transfer area should reduce runoff.
- ✓ Transfer area should be designed to prevent runoff of spilled liquids from the area. Sloping the area to a drain should prevent runoff. The drain should be connected to a dead-end sump. A positive control valve should be installed on the drain.

## Spill Control

*Also see Spill Prevention and Control procedures sheet*

- ✓ Contain leaks during transfer.
- ✓ Use drip pans under hoses.
- ✓ Have an emergency spill cleanup plan readily available.
- ✓ Place spill kits and materials next to or near each loading/unloading area.
- ✓ Use drip pans or comparable devices when transferring oils, solvents, and paints.

## Training

- ✓ Make sure forklift operators are properly trained.
- ✓ Train employees regarding spill containment and cleanup.
- ✓ Employees trained in spill containment and cleanup should be present during the loading/unloading.
- ✓ Use a written operations plan that describes procedures for loading and/or unloading.

## Inspection

*Also see Spill Prevention and Control procedures sheet*

- ✓ Check loading and unloading equipment regularly for leaks, including valves, pumps, flanges and connections.
- ✓ Inspect regularly for leaking valves, pipes, hoses, or soil chutes carrying either water or wastewater.
- ✓ Look for dust or fumes during loading or unloading operations.

---

## LIMITATIONS:

Space and time limitations may preclude all transfers from being performed indoors or under cover. It may not be possible to conduct transfers only during dry weather.

## REFERENCES:

*California Storm Water Best Management Practice Handbooks. Municipal Best Management Practice Handbook.*

## FF-6

*Prepared by Camp Dresser & McKee, Larry Walker Associates, Uribe and Associates, Resources Planning Associates for Stormwater Quality Task Force. March 1993.*

Model Urban Runoff Program: A How-To Guide for Developing Urban Runoff Programs for Small Municipalities. Prepared by City of Monterey, City of Santa Cruz, California Coastal Commission, Monterey Bay National Marine Sanctuary, Association of Monterey Bay Area Governments, Woodward-Clyde, Central Coast Regional Water Quality Control Board. July, 1998.



## ROADS, STREETS, AND HIGHWAYS OPERATION AND MAINTENANCE

Streets, roads, and highways are significant sources of pollutants in storm water discharges, and operation and maintenance (O&M) practices, if not conducted properly, can contribute to the problem. O&M practices may involve one or more of the following activities:

1. Sweeping & Cleaning
2. Street Repair & Maintenance
3. Bridge and Structure Maintenance

Streets, roads, and highways are significant sources of pollutants in storm water discharges, and operation and maintenance (O&M) practices, if not conducted properly, can contribute to the problem. O&M practices may involve one or more of the following activities:

Pollution prevention measures that should be consider and the minimum required and optional model procedures for each performance standard are provided below.

### POLLUTION PREVENTION:

Pollution prevention measures have been considered and incorporated in the model procedures. Implementation of these measures may be more effective and reduce or eliminate the need to implement other more complicated or costly procedures. Possible pollution prevention measure for roads, streets, and highways operation and maintenance include:

- Use the least toxic materials available (e.g. water based paints, gels or sprays for graffiti removal)
- Recycle paint and other materials whenever possible.
- Once per year, educate municipal staff on pollution prevention measures.

## MODEL PROCEDURES:

### 1. Sweeping & Cleaning

#### Sweeping Frequency and Timing

- ✓ Maintain a consistent sweeping schedule. Provide minimum monthly sweeping of streets.
- ✓ Perform street cleaning during dry weather if possible.
- ✓ Avoid wet cleaning or flushing of streets, and utilize dry methods where possible.
- ✓ If flushing of a street is absolutely necessary, sweep and remove debris before flushing. Do not let wash water enter storm drain inlets. Collect wash water and direct to a dirt or vegetated area, pump into a vacuum truck and dispose of properly.

#### OPTIONAL:

- Consider increasing sweeping frequency based on factors such as traffic volume, land use, field observations of sediment and trash accumulation, proximity to water courses, etc.

#### Equipment Operation and Selection

→ *Note: Permission must be obtained for any discharge of wash water to the sanitary sewer from the local sewerage agency.*

- ✓ Maintain cleaning equipment in good working condition and purchase replacement equipment as needed. Old sweepers should be replaced as needed with new technologically advanced sweepers (preferably regenerative air sweepers) that maximize pollutant removal.
- ✓ Operate sweepers at manufacturer requested optimal speed levels to increase effectiveness.
- ✓ Clean sweepers at a wash rack that drains to the sanitary sewer. The wash rack area should be covered and bermed and wash water should drain to a clarifier prior to entering the sanitary sewer.
- ✓ Regularly inspect vehicles and equipment for leaks, and repair immediately.

#### OPTIONAL:

- If available use vacuum or regenerative air sweepers in the high sediment and trash areas (typically industrial/commercial).

#### Management of Material Removed by Sweeping

- ✓ Dispose of street sweeping debris and dirt at a landfill.
- ✓ Do not store swept material along the side of the street or near a storm drain inlet.
- ✓ If dewatering of saturated materials is necessary it should be conducted in a designated area away from storm drain inlets and the water contained for proper disposal.



→ *Note: Permission must be obtained for any discharge of wash water to the sanitary sewer from the local sewerage agency.*

## Maximize Access for Sweepers

- ✓ If authorized by the local sanitation agency, water may be discharged to the sanitary sewer only after passing through a clarifier. As an alternative, dewatering can be conducted in a containment area in which saturated materials are placed on a tarp and allowed to dry. Dry debris is then disposed of properly.
- ✓ Keep debris storage to a minimum during the wet season or make sure debris piles are contained (e.g. by berming the area) or covered (e.g. with tarps or permanent covers).
- ✓ Keep accurate operation logs to track program.
- ✓ Properly maintain and operate equipment; which will increase efficiency.
- ✓ Sweeping should be conducted as close to the curb line as possible.

### OPTIONAL:

- Institute a parking policy to restrict parking in problematic areas during periods of street sweeping.
- Post permanent street sweeping signs in problematic areas; use temporary signs if installation of permanent signs is not possible.
- Develop and distribute flyers notifying residents of street sweeping schedules.

## 2. Repair and Maintenance

### Pavement Marking

- ✓ Develop paint handling procedures for proper use, storage, and disposal of paints.
- ✓ Transfer and load paint and hot thermoplastic away from storm drain inlets.
- ✓ Street or hand sweep thermoplastic grindings. Yellow thermoplastic grindings may require special handling as they may contain lead.
- ✓ Replace paints containing lead and tributyltin with less toxic alternatives.
- ✓ Use water based paints. Clean application equipment in a sink that is connected to the sanitary sewer.
- ✓ Properly store leftover paints if they are to be kept for the next job, or dispose of properly.
- ✓ See *Spill Control procedure sheet* for guidance on the proper cleanup of paint spills.

### Concrete Installation and Repair

- ✓ Avoid mixing excess amounts of fresh concrete or cement mortar on-site. Only mix what is needed for the job.
- ✓ Wash concrete trucks off site or in designated areas on site, such that there is no discharge of concrete wash water into storm drain inlets, open ditches, streets, or other stormwater conveyance structures.

## FP-3

- ✓ Store concrete materials under cover, away from drainage areas.
- ✓ Return leftover materials to the transit mixer. Dispose of small amounts of hardened excess concrete, grout, and mortar in the trash.
- ✓ Do not wash sweepings from exposed aggregate concrete into the street or storm drain. Collect and return sweepings to aggregate base stockpile, or dispose in the trash.
- ✓ When washing poured concrete areas to remove fine particles and expose the aggregate, contain the wash water for proper disposal; do not discharge water to the storm drain system.
- ✓ Do not allow excess concrete to be dumped on-site, except in designated areas.
- ✓ Apply concrete, asphalt, and seal coat during dry weather to allow the material to adequately dry prior to a rain event.
- ✓ When making saw cuts in pavement, use as little water as possible and perform during dry weather. Cover each nearby or appropriate storm drain inlet completely with filter fabric or plastic during the sawing operation and contain the slurry by placing straw bales, sandbags, or gravel dams around the inlets. After the liquid drains or evaporates, shovel or vacuum the slurry residue from the pavement or gutter and remove from site. Alternatively, a small on-site vacuum may be used to pick up the slurry as this will prohibit slurry from reaching storm drain inlets.

### **Patching, Resurfacing, and Surface Sealing**

- ✓ Pre-heat, transfer or load hot bituminous material away from storm drain inlets.
- ✓ Apply concrete, asphalt, and seal coat during dry weather to allow the material to adequately dry prior to a rain event.
- ✓ Where applicable, cover and seal each nearby or appropriate storm drain inlet (with waterproof material, plastic or mesh) and maintenance holes before applying seal coat, slurry seal, etc. Leave covers in place until job is complete and until all water from emulsified oil sealants has drained or evaporated. Clean any debris from covered man holes and storm drain inlets when the job is complete.
- ✓ Use only as much water as necessary for dust control, to avoid runoff.
- ✓ Catch drips from paving equipment that is not in use with pans or absorbent material placed under the machines. Dispose of collected material and absorbents properly.
- ✓ Prior to a rain event or at the completion of a project, sweep the project area by hand or with a street sweeper.

### **Equipment Cleaning, Maintenance, and Storage**

*Also see Equipment Repair &  
Maintenance procedure sheet.*

- ✓ Clean equipment including sprayers, sprayer paint supply lines, patch and paving equipment, and mudjacking equipment at the end of each day. If equipment can be cleaned and materials reapplied at the job site, do so in compliance with the laws and regulations. Clean in a sink or other area (e.g. vehicle wash area) that is connected to the sanitary sewer.

→ *Note: Permission must be obtained for any discharge of wash water to the sanitary sewer from the local sewerage agency.*

- ✓ If refueling or repairing vehicles and equipment must be done on-site, conduct the activity away from storm drain inlets and watercourses.
- ✓ Place drip pans or absorbent materials under heavy equipment when not in use.
- ✓ Clean paint brushes and tools covered with water-based paints in sinks connected to sanitary sewers. Brushes and tools covered with non-water-based paints, finishes, or other materials must be cleaned in a manner that enables collection of used solvents (e.g., paint thinner, turpentine, etc.) for recycling or proper disposal.

OPTIONAL:

- Conduct cleaning at a corporation or maintenance yard if possible.
- When practical, perform major equipment repairs at the corporation yard.

→ *In addition to the procedures above, review and apply general procedures outlined for Minor Construction activities when conducting street, road, and highway repair and maintenance activities.*

## 3. Bridge and Structure Maintenance

### Painting and Paint Removal

- ✓ Transport paint and materials to and from job sites in containers with secure lids and tied down to the transport vehicle.
- ✓ Do not transfer or load paint near storm drain inlets or watercourses.
- ✓ Test and inspect spray equipment prior to starting to paint. Tighten all hoses and connections and do not overfill paint container.
- ✓ If sand blasting is used to remove paint, cover nearby storm drain inlets prior to starting work.
- ✓ If the bridge crosses a watercourse, perform work on a maintenance traveler or platform, or use suspended netting or tarps to capture paint, rust, paint removing agents, or other materials, to prevent discharge of materials to surface waters. If sanding, use a sander with a vacuum filter bag.
- ✓ Recycle paint when possible (e.g. paint may be used for graffiti removal activities). Dispose of paint at an appropriate household hazardous waste facility.
- ✓ See Spill Control procedure sheet for guidance on the proper cleanup of paint spills.

### Graffiti Removal

- ✓ Avoid graffiti abatement activities during rain events.
- ✓ Protect nearby storm drain inlets prior to removing graffiti from walls, signs, sidewalks, or other structures needing graffiti abatement. Clean up

## FP-3

afterwards by sweeping or vacuuming thoroughly, and/or by using absorbent and properly disposing of the absorbent.

- ✓ Note that care should be taken when disposing of waste since it may need to be disposed of as hazardous waste.
- ✓ When graffiti is removed by painting over, implement the procedures under *Painting and Paint Removal* above.
- ✓ Direct runoff from sand blasting and high pressure washing (with no cleaning agents) into a landscaped or dirt area.
- ✓ If a graffiti abatement method generates wash water containing a cleaning compound (such as high pressure washing with a cleaning compound), plug nearby storm drains and collect wash water and dispose of properly.

### OPTIONAL:

- Consider using a waterless and non-toxic chemical cleaning method for graffiti removal (e.g. gels or spray compounds).

### Guardrail and Fence Repair

- ✓ When cleaning guardrails or fences follow the appropriate surface cleaning methods (depending on the type of surface) outlined in the *Sidewalk, Plaza, and Fountain Maintenance and Cleaning* procedure sheet.
- ✓ If painting is conducted, follow the *Painting and Paint Removal* procedures above.
- ✓ If graffiti removal is conducted, follow the *Grffiti Removal* procedures above.
- ✓ If construction takes place, see the procedure sheet for *Minor Construction*.
- ✓ Recycle materials whenever possible.

---

### LIMITATIONS:

Limitations related to street sweeping may include high equipment costs, the potential inability to restrict parking in urban areas, the need for sweeper operator training, the inability of current sweeper technology to remove oil and grease, and the lack of scientific evidence regarding the expected levels of pollutant removal.

### REFERENCES:

*Model Urban Runoff Program: A How-To Guide for Developing Urban Runoff Programs for Small Municipalities. Prepared by City of Monterey, City of Santa Cruz, California Coastal Commission, Monterey Bay National Marine Sanctuary, Association of Monterey Bay Area Governments, Woodward-Clyde, Central Coast Regional Water Quality Control Board. July. 1998.*

Oregon Association of Clean Water Agencies. Oregon Municipal Stormwater Toolbox for Maintenance Practices. June 1998.

Santa Clara Valley Urban Runoff Pollution Prevention Program. 1997 Urban Runoff Management Plan. September 1997, updated October 2000.

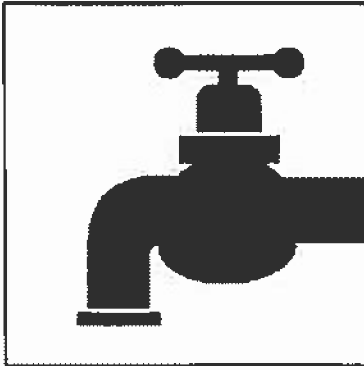

**FP-6**

## **WATER AND SEWER UTILITY OPERATION AND MAINTENANCE**

**Although the operation and maintenance of public utilities are not considered themselves a chronic source of stormwater pollution, some activities and accidents can result in the discharge of pollutants that can pose a threat to both human health and the quality of receiving waters if they enter the storm drain system. Activities associated with the operation and maintenance of water and sewer utilities to prevent and handle such incidents include the following:**

- 1. Water Line Maintenance**
- 2. Sanitary Sewer Maintenance**
- 3. Spill/Leak/Overflow Control, Response, and Containment**

**Cities that do not provide maintenance of water and sewer utilities should coordinate with the contracting agency responsible for these activities and ensure that these model procedures are followed.**

### **POLLUTION PREVENTION:**

Pollution prevention measures have been considered and incorporated in the model procedures. Implementation of these measures may be more effective and reduce or eliminate the need to implement other more complicated or costly procedures. Possible pollution prevention measures for water and sewer utility operation and maintenance include:

- Inspect potential non-storm water discharge flow paths and clear/cleanup any debris or pollutants found (i.e. remove trash, leaves, sediment, and wipe up liquids, including oil spills).
- Once per year, educate municipal staff on pollution prevention measures.

## MODEL PROCEDURES:

### 1. Water Line Maintenance

Procedures can be employed to reduce pollutants from discharges associated with water utility operation and maintenance activities. Planned discharges may include fire hydrant testing, flushing water supply mains after new construction, flushing lines due to complaints of taste and odor, dewatering mains for maintenance work. Unplanned discharges from treated, recycled water, raw water, and groundwater systems operation and maintenance activities can occur from water main breaks, sheared fire hydrants, equipment malfunction, and operator error.

#### Planned Discharges

- ✓ For planned discharges use one of the following options:
  - Reuse water for dust suppression, irrigation, or construction compaction
  - Discharge to the sanitary sewer system with approval
  - Discharge to the storm drain system or to a creek using applicable pollution control measures listed below (this option is ONLY applicable to uncontaminated pumped ground water, water line flushing, fire hydrant testing and flushing, discharges from potable water sources other than water main breaks) and may require a permit from the Regional Water Quality Control Board.
- ✓ If water is discharged to a storm drain inlet (catch basin), control measures must be put in place to control potential pollutants (i.e. sediment, chlorine, etc.). Examples of some storm drain inlet protection options include:
  - Silt fence – appropriate where the inlet drains a relatively flat area.
  - Gravel and wire mesh sediment filter – Appropriate where concentrated flows are expected.
  - Wooden weir and fabric – use at curb inlets where a compact installation is desired.
- ✓ Prior to discharge, inspect discharge flow path and clear/cleanup any debris or pollutants found (i.e. remove trash, leaves, sediment, and wipe up liquids, including oil spills).
- ✓ Select appropriate pollution control measure(s) considering the receiving system (i.e. curb inlet, drop inlet, culvert, creek, etc.) and ensure that the control device(s) fit properly.

- ✓ General design considerations for inlet protection devices include the following:
  - The device should be constructed such that cleaning and disposal of trapped sediment is made easy, while minimizing interference with discharge activities.
  - Devices should be constructed so that any standing water resulting from the discharge will not cause excessive inconvenience or flooding/damage to adjacent land or structures.
- ✓ The effectiveness of control devices must be monitored during the discharge period and any necessary repairs or modifications made as needed.

#### OPTIONAL:

- Sediment removal may be enhanced by placing filter fabric, gravel bags, etc. at storm drain inlets.

#### **Unplanned Discharges**

- ✓ Stop the discharge as quickly as possible by turning off water source.
- ✓ Inspect flow path of the discharged water:
  - Control erosion along the flow path.
  - Identify areas that may produce significant sediment or gullies, use sandbags to redirect the flow.
  - Identify erodible areas which may need to be repaired or protected during subsequent repairs or corrective actions
- ✓ If repairs or corrective action will cause additional discharges of water, select the appropriate procedures for erosion control, chlorine residual, turbidity, and chemical additives. Prevent potential pollutants from entering the flow path and ensure that no additional discharged water enters storm drain inlets.

## 2. Sanitary Sewer Maintenance

Applicable to municipalities who own and operated a sewage collection system. Facilities that are covered under this program include sanitary sewer pipes and pump stations owned and operated by the Permittee. The owner of the sanitary sewer facilities is the entity responsible for carrying out this prevention and response program.

## Sewer System Cleaning

- ✓ Sewer lines should be cleaned on a regular basis to remove grease, grit, and other debris that may lead to sewer backups.
- ✓ Establish routine maintenance program. Cleaning should be conducted at an established minimum frequency and more frequently for problem areas such as restaurants that are identified
- ✓ Cleaning activities may require removal of tree roots and other identified obstructions.

---

## Preventative and Corrective Maintenance

- ✓ During routine maintenance and inspection note the condition of sanitary sewer structures and identify areas that need repair or maintenance. Items to note may include the following:
  - cracked/deteriorating pipes
  - leaking joints/seals at manhole
  - frequent line plugs
  - line generally flows at or near capacity
  - suspected infiltration or exfiltration
- ✓ Document suggestions and requests for repair and report the information to the appropriate manager or supervisor.
- ✓ Prioritize repairs based on the nature and severity of the problem. Immediate clearing of blockage or repair is required where an overflow is currently occurring or for urgent problems that may cause an imminent overflow (e.g. pump station failures, sewer line ruptures, sewer line blockages). These repairs may be temporary until scheduled or capital improvements can be completed.
- ✓ Review previous sewer maintenance records to help identify "hot spots" or areas with frequent maintenance problems and locations of potential system failure.

## 3. Spill/Leak/Overflow Control, Response, and Containment

### Control

*Also see Drainage System procedures sheet*

- ✓ Refer to countywide *Illicit Discharge Detection and Elimination Program*. Components of this program include:
  - Investigation/inspection and follow-up
  - Elimination of illicit discharges and connections
  - Enforcement of ordinances
  - Respond to sewage spills



- Facilitate public reporting of illicit discharges and connections. A citizen's hotline for reporting observed overflow conditions should be established to supplement the field screening efforts being conducted by the Principal Permittee.

## Response and Containment

- ✓ Establish lead department/agency responsible for spill response and containment. Provide coordination within departments.
- ✓ When a spill, leak, and/or overflow occurs, keep sewage from entering the storm drain system to the maximum extent practicable by covering or blocking storm drain inlets or by containing and diverting the sewage away from open channels and other storm drain facilities (using sandbags, inflatable dams, etc.).
- ✓ If a spill reaches the storm drain notify County of Orange Health Care Agency through Control One at (714) 628-7208.
- ✓ Remove the sewage using vacuum equipment or use other measures to divert it back to the sanitary sewer system.
- ✓ Record required information at the spill site.
- ✓ Perform field tests as necessary to determine the source of the spill.
- ✓ Develop additional notification procedures regarding spill reporting as needed.

---

## LIMITATIONS:

Private property access rights needed to perform testing along storm drain right-of-ways. Requirements of municipal ordinance authority for suspected source verification testing necessary for guaranteed rights of entry.

## REFERENCES:

*California Storm Water Best Management Practice Handbooks. Municipal Best Management Practice Handbook. Prepared by Camp Dresser & McKee, Larry Walker Associates, Uribe and Associates, Resources Planning Associates for Stormwater Quality Task Force. March 1993.*

Los Angeles County Stormwater Quality. Public Agency Activities Model Program. On-line:  
[http://ladpw.org/wmd/npdes/public\\_TC.cfm](http://ladpw.org/wmd/npdes/public_TC.cfm)

Santa Clara Valley Urban Runoff Pollution Prevention Program. 1997 Urban Runoff Management Plan. September 1997, updated October 2000.

Santa Clara Valley Urban Runoff Pollution Prevention Program. Water Utility Pollution Prevention Plan.



## Objectives

- Cover
- Contain
- Educate
- Reduce/Minimize
- Product Substitution

## Description

The loading/unloading of materials usually takes place outside on docks or terminals; therefore, materials spilled, leaked, or lost during loading/unloading may collect in the soil or on other surfaces and have the potential to be carried away by stormwater runoff or when the area is cleaned. Additionally, rainfall may wash pollutants from machinery used to unload or move materials. Implementation of the following protocols will prevent or reduce the discharge of pollutants to stormwater from outdoor loading/unloading of materials.

## Approach

Reduce potential for pollutant discharge through source control pollution prevention and BMP implementation. Successful implementation depends on effective training of employees on applicable BMPs and general pollution prevention strategies and objectives.

## Pollution Prevention

- Keep accurate maintenance logs to evaluate materials removed and improvements made.
- Park tank trucks or delivery vehicles in designated areas so that spills or leaks can be contained.
- Limit exposure of material to rainfall whenever possible.
- Prevent stormwater run-on.
- Check equipment regularly for leaks.

## Targeted Constituents

Sediment	✓
Nutrients	✓
Trash	
Metals	✓
Bacteria	
Oil and Grease	✓
Organics	✓



***Suggested Protocols******Loading and Unloading – General Guidelines***

- Develop an operations plan that describes procedures for loading and/or unloading.
- Conduct loading and unloading in dry weather if possible.
- Cover designated loading/unloading areas to reduce exposure of materials to rain.
- Consider placing a seal or door skirt between delivery vehicles and building to prevent exposure to rain.
- Design loading/unloading area to prevent stormwater run-on, which would include grading or berming the area, and position roof downspouts so they direct stormwater away from the loading/unloading areas.
- Have employees load and unload all materials and equipment in covered areas such as building overhangs at loading docks if feasible.
- Load/unload only at designated loading areas.
- Use drip pans underneath hose and pipe connections and other leak-prone spots during liquid transfer operations, and when making and breaking connections. Several drip pans should be stored in a covered location near the liquid transfer area so that they are always available, yet protected from precipitation when not in use. Drip pans can be made specifically for railroad tracks. Drip pans must be cleaned periodically, and drip collected materials must be disposed of properly.
- Pave loading areas with concrete instead of asphalt.
- Avoid placing storm drains in the area.
- Grade and/or berm the loading/unloading area to a drain that is connected to a deadend.

***Inspection***

- Check loading and unloading equipment regularly for leaks, including valves, pumps, flanges and connections.
- Look for dust or fumes during loading or unloading operations.

***Training***

- Train employees (e.g., fork lift operators) and contractors on proper spill containment and cleanup.
- Have employees trained in spill containment and cleanup present during loading/unloading.
- Train employees in proper handling techniques during liquid transfers to avoid spills.
- Make sure forklift operators are properly trained on loading and unloading procedures.

## ***Spill Response and Prevention***

- Keep your Spill Prevention Control and Countermeasure (SPCC) Plan up-to-date.
- Contain leaks during transfer.
- Store and maintain appropriate spill cleanup materials in a location that is readily accessible and known to all and ensure that employees are familiar with the site's spill control plan and proper spill cleanup procedures.
- Have an emergency spill cleanup plan readily available.
- Use drip pans or comparable devices when transferring oils, solvents, and paints.

## ***Other Considerations (Limitations and Regulations)***

- Space and time limitations may preclude all transfers from being performed indoors or under cover.
- It may not be possible to conduct transfers only during dry weather.

## **Requirements**

### ***Costs***

Costs should be low except when covering a large loading/unloading area.

### ***Maintenance***

- Conduct regular inspections and make repairs as necessary. The frequency of repairs will depend on the age of the facility.
- Check loading and unloading equipment regularly for leaks.
- Conduct regular broom dry-sweeping of area.

## **Supplemental Information**

### ***Further Detail of the BMP***

#### ***Special Circumstances for Indoor Loading/Unloading of Materials***

Loading or unloading of liquids should occur in the manufacturing building so that any spills that are not completely retained can be discharged to the sanitary sewer, treatment plant, or treated in a manner consistent with local sewer authorities and permit requirements.

- For loading and unloading tank trucks to above and below ground storage tanks, the following procedures should be used:
  - The area where the transfer takes place should be paved. If the liquid is reactive with the asphalt, Portland cement should be used to pave the area.
  - The transfer area should be designed to prevent run-on of stormwater from adjacent areas. Sloping the pad and using a curb, like a speed bump, around the uphill side of the transfer area should reduce run-on.

- The transfer area should be designed to prevent runoff of spilled liquids from the area. Sloping the area to a drain should prevent runoff. The drain should be connected to a dead-end sump or to the sanitary sewer. A positive control valve should be installed on the drain.
- For transfer from rail cars to storage tanks that must occur outside, use the following procedures:
  - Drip pans should be placed at locations where spillage may occur, such as hose connections, hose reels, and filler nozzles. Use drip pans when making and breaking connections.
  - Drip pan systems should be installed between the rails to collect spillage from tank cars.

**References and Resources**

California's Nonpoint Source Program Plan <http://www.swrcb.ca.gov/nps/index.html>

Clark County Storm Water Pollution Control Manual  
<http://www.co.clark.wa.us/pubworks/bmpman.pdf>

King County Storm Water Pollution Control Manual <http://dnr.metrokc.gov/wlr/dss/spcm.htm>

Santa Clara Valley Urban Runoff Pollution Prevention Program <http://www.scvurppp.org>

The Storm Water Managers Resource Center <http://www.stormwatercenter.net/>



## Description

Stormwater runoff from building and grounds maintenance activities can be contaminated with toxic hydrocarbons in solvents, fertilizers and pesticides, suspended solids, heavy metals, abnormal pH, and oils and greases. Utilizing the protocols in this fact sheet will prevent or reduce the discharge of pollutants to stormwater from building and grounds maintenance activities by washing and cleaning up with as little water as possible, following good landscape management practices, preventing and cleaning up spills immediately, keeping debris from entering the storm drains, and maintaining the stormwater collection system.

## Approach

Reduce potential for pollutant discharge through source control pollution prevention and BMP implementation. Successful implementation depends on effective training of employees on applicable BMPs and general pollution prevention strategies and objectives.

### *Pollution Prevention*

- Switch to non-toxic chemicals for maintenance when possible.
- Choose cleaning agents that can be recycled.
- Encourage proper lawn management and landscaping, including use of native vegetation.

## Objectives

- Cover
- Contain
- Educate
- Reduce/Minimize
- Product Substitution

## Targeted Constituents

Sediment	✓
Nutrients	✓
Trash	
Metals	✓
Bacteria	✓
Oil and Grease	
Organics	



# SC-41 Building & Grounds Maintenance

---

- Encourage use of Integrated Pest Management techniques for pest control.
- Encourage proper onsite recycling of yard trimmings.
- Recycle residual paints, solvents, lumber, and other material as much as possible.

## ***Suggested Protocols***

### *Pressure Washing of Buildings, Rooftops, and Other Large Objects*

- In situations where soaps or detergents are used and the surrounding area is paved, pressure washers must use a water collection device that enables collection of wash water and associated solids. A sump pump, wet vacuum or similarly effective device must be used to collect the runoff and loose materials. The collected runoff and solids must be disposed of properly.
- If soaps or detergents are not used, and the surrounding area is paved, wash runoff does not have to be collected but must be screened. Pressure washers must use filter fabric or some other type of screen on the ground and/or in the catch basin to trap the particles in wash water runoff.
- If you are pressure washing on a grassed area (with or without soap), runoff must be dispersed as sheet flow as much as possible, rather than as a concentrated stream. The wash runoff must remain on the grass and not drain to pavement.

### *Landscaping Activities*

- Dispose of grass clippings, leaves, sticks, or other collected vegetation as garbage, or by composting. Do not dispose of collected vegetation into waterways or storm drainage systems.
- Use mulch or other erosion control measures on exposed soils.

### *Building Repair, Remodeling, and Construction*

- Do not dump any toxic substance or liquid waste on the pavement, the ground, or toward a storm drain.
- Use ground or drop cloths underneath outdoor painting, scraping, and sandblasting work, and properly dispose of collected material daily.
- Use a ground cloth or oversized tub for activities such as paint mixing and tool cleaning.
- Clean paintbrushes and tools covered with water-based paints in sinks connected to sanitary sewers or in portable containers that can be dumped into a sanitary sewer drain. Brushes and tools covered with non-water-based paints, finishes, or other materials must be cleaned in a manner that enables collection of used solvents (e.g., paint thinner, turpentine, etc.) for recycling or proper disposal.
- Use a storm drain cover, filter fabric, or similarly effective runoff control mechanism if dust, grit, wash water, or other pollutants may escape the work area and enter a catch basin. This is particularly necessary on rainy days. The containment device(s) must be in place at the beginning of the work day, and accumulated dirty runoff and solids must be collected and disposed of before removing the containment device(s) at the end of the work day.

- If you need to de-water an excavation site, you may need to filter the water before discharging to a catch basin or off-site. If directed off-site, you should direct the water through hay bales and filter fabric or use other sediment filters or traps.
- Store toxic material under cover during precipitation events and when not in use. A cover would include tarps or other temporary cover material.

### *Mowing, Trimming, and Planting*

- Dispose of leaves, sticks, or other collected vegetation as garbage, by composting or at a permitted landfill. Do not dispose of collected vegetation into waterways or storm drainage systems.
- Use mulch or other erosion control measures when soils are exposed.
- Place temporarily stockpiled material away from watercourses and drain inlets, and berm or cover stockpiles to prevent material releases to the storm drain system.
- Consider an alternative approach when bailing out muddy water: do not put it in the storm drain; pour over landscaped areas.
- Use hand weeding where practical.

### *Fertilizer and Pesticide Management*

- Follow all federal, state, and local laws and regulations governing the use, storage, and disposal of fertilizers and pesticides and training of applicators and pest control advisors.
- Use less toxic pesticides that will do the job when applicable. Avoid use of copper-based pesticides if possible.
- Do not use pesticides if rain is expected.
- Do not mix or prepare pesticides for application near storm drains.
- Use the minimum amount needed for the job.
- Calibrate fertilizer distributors to avoid excessive application.
- Employ techniques to minimize off-target application (e.g., spray drift) of pesticides, including consideration of alternative application techniques.
- Apply pesticides only when wind speeds are low.
- Fertilizers should be worked into the soil rather than dumped or broadcast onto the surface.
- Irrigate slowly to prevent runoff and then only as much as is needed.
- Clean pavement and sidewalk if fertilizer is spilled on these surfaces before applying irrigation water.
- Dispose of empty pesticide containers according to the instructions on the container label.



# **SC-41 Building & Grounds Maintenance**

---

- Use up the pesticides. Rinse containers, and use rinse water as product. Dispose of unused pesticide as hazardous waste.
- Implement storage requirements for pesticide products with guidance from the local fire department and County Agricultural Commissioner. Provide secondary containment for pesticides.

## ***Inspection***

- Inspect irrigation system periodically to ensure that the right amount of water is being applied and that excessive runoff is not occurring. Minimize excess watering and repair leaks in the irrigation system as soon as they are observed.

## ***Training***

- Educate and train employees on pesticide use and in pesticide application techniques to prevent pollution.
- Train employees and contractors in proper techniques for spill containment and cleanup.
- Be sure the frequency of training takes into account the complexity of the operations and the nature of the staff.

## ***Spill Response and Prevention***

- Keep your Spill Prevention Control and Countermeasure (SPCC) Plan up-to-date.
- Place a stockpile of spill cleanup materials, such as brooms, dustpans, and vacuum sweepers (if desired) near the storage area where it will be readily accessible.
- Have employees trained in spill containment and cleanup present during the loading/unloading of dangerous wastes, liquid chemicals, or other materials.
- Familiarize employees with the Spill Prevention Control and Countermeasure Plan.
- Clean up spills immediately.

## ***Other Considerations***

Alternative pest/weed controls may not be available, suitable, or effective in many cases.

## **Requirements**

### ***Costs***

- Cost will vary depending on the type and size of facility.
- Overall costs should be low in comparison to other BMPs.

### ***Maintenance***

Sweep paved areas regularly to collect loose particles. Wipe up spills with rags and other absorbent material immediately, do not hose down the area to a storm drain.

## Supplemental Information

### *Further Detail of the BMP*

#### *Fire Sprinkler Line Flushing*

Building fire sprinkler line flushing may be a source of non-stormwater runoff pollution. The water entering the system is usually potable water, though in some areas it may be non-potable reclaimed wastewater. There are subsequent factors that may drastically reduce the quality of the water in such systems. Black iron pipe is usually used since it is cheaper than potable piping, but it is subject to rusting and results in lower quality water. Initially, the black iron pipe has an oil coating to protect it from rusting between manufacture and installation; this will contaminate the water from the first flush but not from subsequent flushes. Nitrates, poly-phosphates and other corrosion inhibitors, as well as fire suppressants and antifreeze may be added to the sprinkler water system. Water generally remains in the sprinkler system a long time (typically a year) and between flushes may accumulate iron, manganese, lead, copper, nickel, and zinc. The water generally becomes anoxic and contains living and dead bacteria and breakdown products from chlorination. This may result in a significant BOD problem and the water often smells. Consequently dispose fire sprinkler line flush water into the sanitary sewer. Do not allow discharge to storm drain or infiltration due to potential high levels of pollutants in fire sprinkler line water.

## References and Resources

California's Nonpoint Source Program Plan <http://www.swrcb.ca.gov/nps/index.html>

Clark County Storm Water Pollution Control Manual  
<http://www.co.clark.wa.us/pubworks/bmpman.pdf>

King County Storm Water Pollution Control Manual <http://dnr.metrokc.gov/wlr/dss/spcm.htm>

Mobile Cleaners Pilot Program: Final Report. 1997. Bay Area Stormwater Management Agencies Association (BASMAA). <http://www.basmaa.org/>

Pollution from Surface Cleaning Folder. 1996. Bay Area Stormwater Management Agencies Association (BASMAA). <http://www.basmaa.org/>

Santa Clara Valley Urban Runoff Pollution Prevention Program <http://www.scvurppp.org>

The Storm Water Managers Resource Center <http://www.stormwatercenter.net/>

# Site Design & Landscape Planning SD-10



## Design Objectives

- Maximize Infiltration
- Provide Retention
- Slow Runoff
- Minimize Impervious Land Coverage
- Prohibit Dumping of Improper Materials
- Contain Pollutants
- Collect and Convey

## Description

Each project site possesses unique topographic, hydrologic, and vegetative features, some of which are more suitable for development than others. Integrating and incorporating appropriate landscape planning methodologies into the project design is the most effective action that can be done to minimize surface and groundwater contamination from stormwater.

## Approach

Landscape planning should couple consideration of land suitability for urban uses with consideration of community goals and projected growth. Project plan designs should conserve natural areas to the extent possible, maximize natural water storage and infiltration opportunities, and protect slopes and channels.

## Suitable Applications

Appropriate applications include residential, commercial and industrial areas planned for development or redevelopment.

## Design Considerations

Design requirements for site design and landscapes planning should conform to applicable standards and specifications of agencies with jurisdiction and be consistent with applicable General Plan and Local Area Plan policies.



# **SD-10 Site Design & Landscape Planning**

---

## ***Designing New Installations***

Begin the development of a plan for the landscape unit with attention to the following general principles:

- Formulate the plan on the basis of clearly articulated community goals. Carefully identify conflicts and choices between retaining and protecting desired resources and community growth.
- Map and assess land suitability for urban uses. Include the following landscape features in the assessment: wooded land, open unwooded land, steep slopes, erosion-prone soils, foundation suitability, soil suitability for waste disposal, aquifers, aquifer recharge areas, wetlands, floodplains, surface waters, agricultural lands, and various categories of urban land use. When appropriate, the assessment can highlight outstanding local or regional resources that the community determines should be protected (e.g., a scenic area, recreational area, threatened species habitat, farmland, fish run). Mapping and assessment should recognize not only these resources but also additional areas needed for their sustenance.

Project plan designs should conserve natural areas to the extent possible, maximize natural water storage and infiltration opportunities, and protect slopes and channels.

## ***Conserve Natural Areas during Landscape Planning***

If applicable, the following items are required and must be implemented in the site layout during the subdivision design and approval process, consistent with applicable General Plan and Local Area Plan policies:

- Cluster development on least-sensitive portions of a site while leaving the remaining land in a natural undisturbed condition.
- Limit clearing and grading of native vegetation at a site to the minimum amount needed to build lots, allow access, and provide fire protection.
- Maximize trees and other vegetation at each site by planting additional vegetation, clustering tree areas, and promoting the use of native and/or drought tolerant plants.
- Promote natural vegetation by using parking lot islands and other landscaped areas.
- Preserve riparian areas and wetlands.

## ***Maximize Natural Water Storage and Infiltration Opportunities Within the Landscape Unit***

- Promote the conservation of forest cover. Building on land that is already deforested affects basin hydrology to a lesser extent than converting forested land. Loss of forest cover reduces interception storage, detention in the organic forest floor layer, and water losses by evapotranspiration, resulting in large peak runoff increases and either their negative effects or the expense of countering them with structural solutions.
- Maintain natural storage reservoirs and drainage corridors, including depressions, areas of permeable soils, swales, and intermittent streams. Develop and implement policies and

# Site Design & Landscape Planning SD-10

---

regulations to discourage the clearing, filling, and channelization of these features. Utilize them in drainage networks in preference to pipes, culverts, and engineered ditches.

- Evaluating infiltration opportunities by referring to the stormwater management manual for the jurisdiction and pay particular attention to the selection criteria for avoiding groundwater contamination, poor soils, and hydrogeological conditions that cause these facilities to fail. If necessary, locate developments with large amounts of impervious surfaces or a potential to produce relatively contaminated runoff away from groundwater recharge areas.

## *Protection of Slopes and Channels during Landscape Design*

- Convey runoff safely from the tops of slopes.
- Avoid disturbing steep or unstable slopes.
- Avoid disturbing natural channels.
- Stabilize disturbed slopes as quickly as possible.
- Vegetate slopes with native or drought tolerant vegetation.
- Control and treat flows in landscaping and/or other controls prior to reaching existing natural drainage systems.
- Stabilize temporary and permanent channel crossings as quickly as possible, and ensure that increases in run-off velocity and frequency caused by the project do not erode the channel.
- Install energy dissipaters, such as riprap, at the outlets of new storm drains, culverts, conduits, or channels that enter unlined channels in accordance with applicable specifications to minimize erosion. Energy dissipaters shall be installed in such a way as to minimize impacts to receiving waters.
- Line on-site conveyance channels where appropriate, to reduce erosion caused by increased flow velocity due to increases in tributary impervious area. The first choice for linings should be grass or some other vegetative surface, since these materials not only reduce runoff velocities, but also provide water quality benefits from filtration and infiltration. If velocities in the channel are high enough to erode grass or other vegetative linings, riprap, concrete, soil cement, or geo-grid stabilization are other alternatives.
- Consider other design principles that are comparable and equally effective.

## *Redeveloping Existing Installations*

Various jurisdictional stormwater management and mitigation plans (SUSMP, WQMP, etc.) define “redevelopment” in terms of amounts of additional impervious area, increases in gross floor area and/or exterior construction, and land disturbing activities with structural or impervious surfaces. The definition of “redevelopment” must be consulted to determine whether or not the requirements for new development apply to areas intended for redevelopment. If the definition applies, the steps outlined under “designing new installations” above should be followed.

## **SD-10 Site Design & Landscape Planning**

Redevelopment may present significant opportunity to add features which had not previously been implemented. Examples include incorporation of depressions, areas of permeable soils, and swales in newly redeveloped areas. While some site constraints may exist due to the status of already existing infrastructure, opportunities should not be missed to maximize infiltration, slow runoff, reduce impervious areas, disconnect directly connected impervious areas.

### **Other Resources**

A Manual for the Standard Urban Stormwater Mitigation Plan (SUSMP), Los Angeles County Department of Public Works, May 2002.

Stormwater Management Manual for Western Washington, Washington State Department of Ecology, August 2001.

Model Standard Urban Storm Water Mitigation Plan (SUSMP) for San Diego County, Port of San Diego, and Cities in San Diego County, February 14, 2002.

Model Water Quality Management Plan (WQMP) for County of Orange, Orange County Flood Control District, and the Incorporated Cities of Orange County, Draft February 2003.

Ventura Countywide Technical Guidance Manual for Stormwater Quality Control Measures, July 2002.



Rain Garden

## Design Objectives

- Maximize Infiltration
- Provide Retention
- Slow Runoff
- Minimize Impervious Land Coverage
- Prohibit Dumping of Improper Materials
- Contain Pollutants
- Collect and Convey

## Description

Various roof runoff controls are available to address stormwater that drains off rooftops. The objective is to reduce the total volume and rate of runoff from individual lots, and retain the pollutants on site that may be picked up from roofing materials and atmospheric deposition. Roof runoff controls consist of directing the roof runoff away from paved areas and mitigating flow to the storm drain system through one of several general approaches: cisterns or rain barrels; dry wells or infiltration trenches; pop-up emitters, and foundation planting. The first three approaches require the roof runoff to be contained in a gutter and downspout system. Foundation planting provides a vegetated strip under the drip line of the roof.

## Approach

Design of individual lots for single-family homes as well as lots for higher density residential and commercial structures should consider site design provisions for containing and infiltrating roof runoff or directing roof runoff to vegetative swales or buffer areas. Retained water can be reused for watering gardens, lawns, and trees. Benefits to the environment include reduced demand for potable water used for irrigation, improved stormwater quality, increased groundwater recharge, decreased runoff volume and peak flows, and decreased flooding potential.

## Suitable Applications

Appropriate applications include residential, commercial and industrial areas planned for development or redevelopment.

## Design Considerations

### *Designing New Installations*

#### *Cisterns or Rain Barrels*

One method of addressing roof runoff is to direct roof downspouts to cisterns or rain barrels. A cistern is an above ground storage vessel with either a manually operated valve or a permanently open outlet. Roof runoff is temporarily stored and then released for irrigation or infiltration between storms. The number of rain



barrels needed is a function of the rooftop area. Some low impact developers recommend that every house have at least 2 rain barrels, with a minimum storage capacity of 1000 liters. Roof barrels serve several purposes including mitigating the first flush from the roof which has a high volume, amount of contaminants, and thermal load. Several types of rain barrels are commercially available. Consideration must be given to selecting rain barrels that are vector proof and childproof. In addition, some barrels are designed with a bypass valve that filters out grit and other contaminants and routes overflow to a soak-away pit or rain garden.

If the cistern has an operable valve, the valve can be closed to store stormwater for irrigation or infiltration between storms. This system requires continual monitoring by the resident or grounds crews, but provides greater flexibility in water storage and metering. If a cistern is provided with an operable valve and water is stored inside for long periods, the cistern must be covered to prevent mosquitoes from breeding.

A cistern system with a permanently open outlet can also provide for metering stormwater runoff. If the cistern outlet is significantly smaller than the size of the downspout inlet (say  $\frac{1}{4}$  to  $\frac{1}{2}$  inch diameter), runoff will build up inside the cistern during storms, and will empty out slowly after peak intensities subside. This is a feasible way to mitigate the peak flow increases caused by rooftop impervious land coverage, especially for the frequent, small storms.

#### *Dry wells and Infiltration Trenches*

Roof downspouts can be directed to dry wells or infiltration trenches. A dry well is constructed by excavating a hole in the ground and filling it with an open graded aggregate, and allowing the water to fill the dry well and infiltrate after the storm event. An underground connection from the downspout conveys water into the dry well, allowing it to be stored in the voids. To minimize sedimentation from lateral soil movement, the sides and top of the stone storage matrix can be wrapped in a permeable filter fabric, though the bottom may remain open. A perforated observation pipe can be inserted vertically into the dry well to allow for inspection and maintenance.

In practice, dry wells receiving runoff from single roof downspouts have been successful over long periods because they contain very little sediment. They must be sized according to the amount of rooftop runoff received, but are typically 4 to 5 feet square, and 2 to 3 feet deep, with a minimum of 1-foot soil cover over the top (maximum depth of 10 feet).

To protect the foundation, dry wells must be set away from the building at least 10 feet. They must be installed in solids that accommodate infiltration. In poorly drained soils, dry wells have very limited feasibility.

Infiltration trenches function in a similar manner and would be particularly effective for larger roof areas. An infiltration trench is a long, narrow, rock-filled trench with no outlet that receives stormwater runoff. These are described under Treatment Controls.

#### *Pop-up Drainage Emitter*

Roof downspouts can be directed to an underground pipe that daylights some distance from the building foundation, releasing the roof runoff through a pop-up emitter. Similar to a pop-up irrigation head, the emitter only opens when there is flow from the roof. The emitter remains flush to the ground during dry periods, for ease of lawn or landscape maintenance.



## *Foundation Planting*

Landscape planting can be provided around the base to allow increased opportunities for stormwater infiltration and protect the soil from erosion caused by concentrated sheet flow coming off the roof. Foundation plantings can reduce the physical impact of water on the soil and provide a subsurface matrix of roots that encourage infiltration. These plantings must be sturdy enough to tolerate the heavy runoff sheet flows, and periodic soil saturation.

## ***Redeveloping Existing Installations***

Various jurisdictional stormwater management and mitigation plans (SUSMP, WQMP, etc.) define “redevelopment” in terms of amounts of additional impervious area, increases in gross floor area and/or exterior construction, and land disturbing activities with structural or impervious surfaces. The definition of “redevelopment” must be consulted to determine whether or not the requirements for new development apply to areas intended for redevelopment. If the definition applies, the steps outlined under “designing new installations” above should be followed.

## **Supplemental Information**

### ***Examples***

- City of Ottawa’s Water Links Surface –Water Quality Protection Program
- City of Toronto Downspout Disconnection Program
- City of Boston, MA, Rain Barrel Demonstration Program

## **Other Resources**

Hager, Marty Catherine, Stormwater, “Low-Impact Development”, January/February 2003.  
[www.stormh2o.com](http://www.stormh2o.com)

Low Impact Urban Design Tools, Low Impact Development Design Center, Beltsville, MD.  
[www.lid-stormwater.net](http://www.lid-stormwater.net)

Start at the Source, Bay Area Stormwater Management Agencies Association, 1999 Edition



## Design Objectives

- Maximize Infiltration
- Provide Retention
- Slow Runoff
- Minimize Impervious Land Coverage
- Prohibit Dumping of Improper Materials
- Contain Pollutants
- Collect and Convey

## Description

Irrigation water provided to landscaped areas may result in excess irrigation water being conveyed into stormwater drainage systems.

## Approach

Project plan designs for development and redevelopment should include application methods of irrigation water that minimize runoff of excess irrigation water into the stormwater conveyance system.

## Suitable Applications

Appropriate applications include residential, commercial and industrial areas planned for development or redevelopment. (Detached residential single-family homes are typically excluded from this requirement.)

## Design Considerations

### *Designing New Installations*

The following methods to reduce excessive irrigation runoff should be considered, and incorporated and implemented where determined applicable and feasible by the Permittee:

- Employ rain-triggered shutoff devices to prevent irrigation after precipitation.
- Design irrigation systems to each landscape area's specific water requirements.
- Include design featuring flow reducers or shutoff valves triggered by a pressure drop to control water loss in the event of broken sprinkler heads or lines.
- Implement landscape plans consistent with County or City water conservation resolutions, which may include provision of water sensors, programmable irrigation times (for short cycles), etc.



- Design timing and application methods of irrigation water to minimize the runoff of excess irrigation water into the storm water drainage system.
- Group plants with similar water requirements in order to reduce excess irrigation runoff and promote surface filtration. Choose plants with low irrigation requirements (for example, native or drought tolerant species). Consider design features such as:
  - Using mulches (such as wood chips or bar) in planter areas without ground cover to minimize sediment in runoff
  - Installing appropriate plant materials for the location, in accordance with amount of sunlight and climate, and use native plant materials where possible and/or as recommended by the landscape architect
  - Leaving a vegetative barrier along the property boundary and interior watercourses, to act as a pollutant filter, where appropriate and feasible
  - Choosing plants that minimize or eliminate the use of fertilizer or pesticides to sustain growth
- Employ other comparable, equally effective methods to reduce irrigation water runoff.

***Redeveloping Existing Installations***

Various jurisdictional stormwater management and mitigation plans (SUSMP, WQMP, etc.) define “redevelopment” in terms of amounts of additional impervious area, increases in gross floor area and/or exterior construction, and land disturbing activities with structural or impervious surfaces. The definition of “redevelopment” must be consulted to determine whether or not the requirements for new development apply to areas intended for redevelopment. If the definition applies, the steps outlined under “designing new installations” above should be followed.

**Other Resources**

A Manual for the Standard Urban Stormwater Mitigation Plan (SUSMP), Los Angeles County Department of Public Works, May 2002.

Model Standard Urban Storm Water Mitigation Plan (SUSMP) for San Diego County, Port of San Diego, and Cities in San Diego County, February 14, 2002.

Model Water Quality Management Plan (WQMP) for County of Orange, Orange County Flood Control District, and the Incorporated Cities of Orange County, Draft February 2003.

Ventura Countywide Technical Guidance Manual for Stormwater Quality Control Measures, July 2002.



## Design Objectives

- Maximize Infiltration
- Provide Retention
- Slow Runoff
- Minimize Impervious Land Coverage
- Prohibit Dumping of Improper Materials
- Contain Pollutants
- Collect and Convey

## Description

Waste materials dumped into storm drain inlets can have severe impacts on receiving and ground waters. Posting notices regarding discharge prohibitions at storm drain inlets can prevent waste dumping. Storm drain signs and stencils are highly visible source controls that are typically placed directly adjacent to storm drain inlets.

## Approach

The stencil or affixed sign contains a brief statement that prohibits dumping of improper materials into the urban runoff conveyance system. Storm drain messages have become a popular method of alerting the public about the effects of and the prohibitions against waste disposal.

## Suitable Applications

Stencils and signs alert the public to the destination of pollutants discharged to the storm drain. Signs are appropriate in residential, commercial, and industrial areas, as well as any other area where contributions or dumping to storm drains is likely.

## Design Considerations

Storm drain message markers or placards are recommended at all storm drain inlets within the boundary of a development project. The marker should be placed in clear sight facing toward anyone approaching the inlet from either side. All storm drain inlet locations should be identified on the development site map.

## Designing New Installations

The following methods should be considered for inclusion in the project design and show on project plans:

- Provide stenciling or labeling of all storm drain inlets and catch basins, constructed or modified, within the project area with prohibitive language. Examples include “NO DUMPING



– DRAINS TO OCEAN” and/or other graphical icons to discourage illegal dumping.

- Post signs with prohibitive language and/or graphical icons, which prohibit illegal dumping at public access points along channels and creeks within the project area.

Note - Some local agencies have approved specific signage and/or storm drain message placards for use. Consult local agency stormwater staff to determine specific requirements for placard types and methods of application.

### ***Redeveloping Existing Installations***

Various jurisdictional stormwater management and mitigation plans (SUSMP, WQMP, etc.) define “redevelopment” in terms of amounts of additional impervious area, increases in gross floor area and/or exterior construction, and land disturbing activities with structural or impervious surfaces. If the project meets the definition of “redevelopment”, then the requirements stated under “designing new installations” above should be included in all project design plans.

### **Additional Information**

#### ***Maintenance Considerations***

- Legibility of markers and signs should be maintained. If required by the agency with jurisdiction over the project, the owner/operator or homeowner’s association should enter into a maintenance agreement with the agency or record a deed restriction upon the property title to maintain the legibility of placards or signs.

#### ***Placement***

- Signage on top of curbs tends to weather and fade.
- Signage on face of curbs tends to be worn by contact with vehicle tires and sweeper brooms.

### **Supplemental Information**

#### ***Examples***

- Most MS4 programs have storm drain signage programs. Some MS4 programs will provide stencils, or arrange for volunteers to stencil storm drains as part of their outreach program.

### **Other Resources**

A Manual for the Standard Urban Stormwater Mitigation Plan (SUSMP), Los Angeles County Department of Public Works, May 2002.

Model Standard Urban Storm Water Mitigation Plan (SUSMP) for San Diego County, Port of San Diego, and Cities in San Diego County, February 14, 2002.

Model Water Quality Management Plan (WQMP) for County of Orange, Orange County Flood Control District, and the Incorporated Cities of Orange County, Draft February 2003.

Ventura Countywide Technical Guidance Manual for Stormwater Quality Control Measures, July 2002.



## Design Objectives

- Maximize Infiltration
- Provide Retention
- Slow Runoff
- Minimize Impervious Land Coverage
- Prohibit Dumping of Improper Materials
- Contain Pollutants
- Collect and Convey

## Description

Several measures can be taken to prevent operations at maintenance bays and loading docks from contributing a variety of toxic compounds, oil and grease, heavy metals, nutrients, suspended solids, and other pollutants to the stormwater conveyance system.

## Approach

In designs for maintenance bays and loading docks, containment is encouraged. Preventative measures include overflow containment structures and dead-end sumps. However, in the case of loading docks from grocery stores and warehouse/distribution centers, engineered infiltration systems may be considered.

## Suitable Applications

Appropriate applications include commercial and industrial areas planned for development or redevelopment.

## Design Considerations

Design requirements for vehicle maintenance and repair are governed by Building and Fire Codes, and by current local agency ordinances, and zoning requirements. The design criteria described in this fact sheet are meant to enhance and be consistent with these code requirements.

## Designing New Installations

Designs of maintenance bays should consider the following:

- Repair/maintenance bays and vehicle parts with fluids should be indoors; or designed to preclude urban run-on and runoff.
- Repair/maintenance floor areas should be paved with Portland cement concrete (or equivalent smooth impervious surface).



- Repair/maintenance bays should be designed to capture all wash water leaks and spills. Provide impermeable berms, drop inlets, trench catch basins, or overflow containment structures around repair bays to prevent spilled materials and wash-down waters from entering the storm drain system. Connect drains to a sump for collection and disposal. Direct connection of the repair/maintenance bays to the storm drain system is prohibited. If required by local jurisdiction, obtain an Industrial Waste Discharge Permit.
- Other features may be comparable and equally effective.

The following designs of loading/unloading dock areas should be considered:

- Loading dock areas should be covered, or drainage should be designed to preclude urban run-on and runoff.
- Direct connections into storm drains from depressed loading docks (truck wells) are prohibited.
- Below-grade loading docks from grocery stores and warehouse/distribution centers of fresh food items should drain through water quality inlets, or to an engineered infiltration system, or an equally effective alternative. Pre-treatment may also be required.
- Other features may be comparable and equally effective.

### ***Redeveloping Existing Installations***

Various jurisdictional stormwater management and mitigation plans (SUSMP, WQMP, etc.) define “redevelopment” in terms of amounts of additional impervious area, increases in gross floor area and/or exterior construction, and land disturbing activities with structural or impervious surfaces. The definition of “redevelopment” must be consulted to determine whether or not the requirements for new development apply to areas intended for redevelopment. If the definition applies, the steps outlined under “designing new installations” above should be followed.

### **Additional Information**

Stormwater and non-stormwater will accumulate in containment areas and sumps with impervious surfaces. Contaminated accumulated water must be disposed of in accordance with applicable laws and cannot be discharged directly to the storm drain or sanitary sewer system without the appropriate permit.

### **Other Resources**

A Manual for the Standard Urban Stormwater Mitigation Plan (SUSMP), Los Angeles County Department of Public Works, May 2002.

Model Standard Urban Storm Water Mitigation Plan (SUSMP) for San Diego County, Port of San Diego, and Cities in San Diego County, February 14, 2002.

Model Water Quality Management Plan (WQMP) for County of Orange, Orange County Flood Control District, and the Incorporated Cities of Orange County, Draft February 2003.

Ventura Countywide Technical Guidance Manual for Stormwater Quality Control Measures, July 2002.

## Description

Trash storage areas are areas where a trash receptacle (s) are located for use as a repository for solid wastes. Stormwater runoff from areas where trash is stored or disposed of can be polluted. In addition, loose trash and debris can be easily transported by water or wind into nearby storm drain inlets, channels, and/or creeks. Waste handling operations that may be sources of stormwater pollution include dumpsters, litter control, and waste piles.

## Approach

This fact sheet contains details on the specific measures required to prevent or reduce pollutants in stormwater runoff associated with trash storage and handling. Preventative measures including enclosures, containment structures, and impervious pavements to mitigate spills, should be used to reduce the likelihood of contamination.

## Suitable Applications

Appropriate applications include residential, commercial and industrial areas planned for development or redevelopment. (Detached residential single-family homes are typically excluded from this requirement.)

## Design Considerations

Design requirements for waste handling areas are governed by Building and Fire Codes, and by current local agency ordinances and zoning requirements. The design criteria described in this fact sheet are meant to enhance and be consistent with these code and ordinance requirements. Hazardous waste should be handled in accordance with legal requirements established in Title 22, California Code of Regulation.

Wastes from commercial and industrial sites are typically hauled by either public or commercial carriers that may have design or access requirements for waste storage areas. The design criteria in this fact sheet are recommendations and are not intended to be in conflict with requirements established by the waste hauler. The waste hauler should be contacted prior to the design of your site trash collection areas. Conflicts or issues should be discussed with the local agency.

## Designing New Installations

Trash storage areas should be designed to consider the following structural or treatment control BMPs:

- Design trash container areas so that drainage from adjoining roofs and pavement is diverted around the area(s) to avoid run-on. This might include berming or grading the waste handling area to prevent run-on of stormwater.
- Make sure trash container areas are screened or walled to prevent off-site transport of trash.

## Design Objectives

- Maximize Infiltration
- Provide Retention
- Slow Runoff
- Minimize Impervious Land Coverage
- Prohibit Dumping of Improper Materials
- Contain Pollutants
- Collect and Convey





- Use lined bins or dumpsters to reduce leaking of liquid waste.
- Provide roofs, awnings, or attached lids on all trash containers to minimize direct precipitation and prevent rainfall from entering containers.
- Pave trash storage areas with an impervious surface to mitigate spills.
- Do not locate storm drains in immediate vicinity of the trash storage area.
- Post signs on all dumpsters informing users that hazardous materials are not to be disposed of therein.

***Redeveloping Existing Installations***

Various jurisdictional stormwater management and mitigation plans (SUSMP, WQMP, etc.) define “redevelopment” in terms of amounts of additional impervious area, increases in gross floor area and/or exterior construction, and land disturbing activities with structural or impervious surfaces. The definition of “redevelopment” must be consulted to determine whether or not the requirements for new development apply to areas intended for redevelopment. If the definition applies, the steps outlined under “designing new installations” above should be followed.

**Additional Information*****Maintenance Considerations***

The integrity of structural elements that are subject to damage (i.e., screens, covers, and signs) must be maintained by the owner/operator. Maintenance agreements between the local agency and the owner/operator may be required. Some agencies will require maintenance deed restrictions to be recorded of the property title. If required by the local agency, maintenance agreements or deed restrictions must be executed by the owner/operator before improvement plans are approved.

**Other Resources**

A Manual for the Standard Urban Stormwater Mitigation Plan (SUSMP), Los Angeles County Department of Public Works, May 2002.

Model Standard Urban Storm Water Mitigation Plan (SUSMP) for San Diego County, Port of San Diego, and Cities in San Diego County, February 14, 2002.

Model Water Quality Management Plan (WQMP) for County of Orange, Orange County Flood Control District, and the Incorporated Cities of Orange County, Draft February 2003.

Ventura Countywide Technical Guidance Manual for Stormwater Quality Control Measures, July 2002.



## Description and Purpose

Street sweeping and vacuuming includes use of self-propelled and walk-behind equipment to remove sediment from streets and roadways, and to clean paved surfaces in preparation for final paving. Sweeping and vacuuming prevents sediment from the project site from entering storm drains or receiving waters.

## Suitable Applications

Sweeping and vacuuming are suitable anywhere sediment is tracked from the project site onto public or private paved streets and roads, typically at points of egress. Sweeping and vacuuming are also applicable during preparation of paved surfaces for final paving.

## Limitations

Sweeping and vacuuming may not be effective when sediment is wet or when tracked soil is caked (caked soil may need to be scraped loose).

## Implementation

- Controlling the number of points where vehicles can leave the site will allow sweeping and vacuuming efforts to be focused, and perhaps save money.
- Inspect potential sediment tracking locations daily.
- Visible sediment tracking should be swept or vacuumed on a daily basis.
- Do not use kick brooms or sweeper attachments. These tend to spread the dirt rather than remove it.

## Categories

EC	Erosion Control	
SE	Sediment Control	<input checked="" type="checkbox"/>
TC	Tracking Control	<input checked="" type="checkbox"/>
WE	Wind Erosion Control	
NS	Non-Stormwater Management Control	
WM	Waste Management and Materials Pollution Control	

## Legend:

- Primary Objective
- Secondary Objective

## Targeted Constituents

Sediment	<input checked="" type="checkbox"/>
Nutrients	
Trash	<input checked="" type="checkbox"/>
Metals	
Bacteria	
Oil and Grease	<input checked="" type="checkbox"/>
Organics	

## Potential Alternatives

None



- If not mixed with debris or trash, consider incorporating the removed sediment back into the project

## Costs

Rental rates for self-propelled sweepers vary depending on hopper size and duration of rental. Expect rental rates from \$58/hour (3 yd<sup>3</sup> hopper) to \$88/hour (9 yd<sup>3</sup> hopper), plus operator costs. Hourly production rates vary with the amount of area to be swept and amount of sediment. Match the hopper size to the area and expect sediment load to minimize time spent dumping.

## Inspection and Maintenance

- Inspect BMPs in accordance with General Permit requirements for the associated project type and risk level. It is recommended that at a minimum, BMPs be inspected weekly, prior to forecasted rain events, daily during extended rain events, and after the conclusion of rain events.
- When actively in use, points of ingress and egress must be inspected daily.
- When tracked or spilled sediment is observed outside the construction limits, it must be removed at least daily. More frequent removal, even continuous removal, may be required in some jurisdictions.
- Be careful not to sweep up any unknown substance or any object that may be potentially hazardous.
- Adjust brooms frequently; maximize efficiency of sweeping operations.
- After sweeping is finished, properly dispose of sweeper wastes at an approved dumpsite.

## References

Stormwater Quality Handbooks - Construction Site Best Management Practices (BMPs) Manual, State of California Department of Transportation (Caltrans), November 2000.

Labor Surcharge and Equipment Rental Rates, State of California Department of Transportation (Caltrans), April 1, 2002 – March 31, 2003.

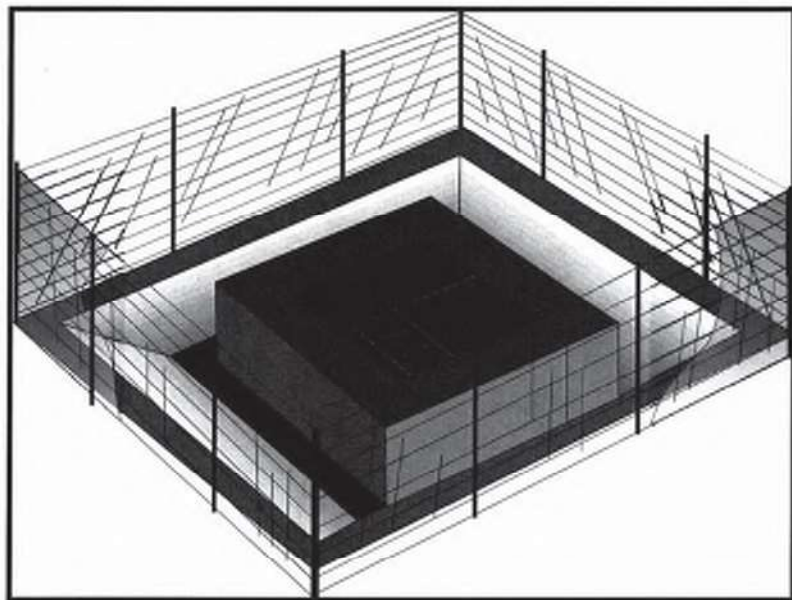

## Description and Purpose

Storm drain inlet protection consists of a sediment filter or an impounding area in, around or upstream of a storm drain, drop inlet, or curb inlet. Storm drain inlet protection measures temporarily pond runoff before it enters the storm drain, allowing sediment to settle. Some filter configurations also remove sediment by filtering, but usually the ponding action results in the greatest sediment reduction. Temporary geotextile storm drain inserts attach underneath storm drain grates to capture and filter storm water.

## Suitable Applications

Every storm drain inlet receiving runoff from unstabilized or otherwise active work areas should be protected. Inlet protection should be used in conjunction with other erosion and sediment controls to prevent sediment-laden stormwater and non-stormwater discharges from entering the storm drain system.

## Limitations

- Drainage area should not exceed 1 acre.
- In general straw bales should not be used as inlet protection.
- Requires an adequate area for water to pond without encroaching into portions of the roadway subject to traffic.

## Categories

EC	Erosion Control	
SE	Sediment Control	<input checked="" type="checkbox"/>
TC	Tracking Control	
WE	Wind Erosion Control	
NS	Non-Stormwater Management Control	
WM	Waste Management and Materials Pollution Control	

## Legend:

- Primary Category
- Secondary Category

## Targeted Constituents

Sediment	<input checked="" type="checkbox"/>
Nutrients	
Trash	<input type="checkbox"/>
Metals	
Bacteria	
Oil and Grease	
Organics	

## Potential Alternatives

- SE-1 Silt Fence
- SE-5 Fiber Rolls
- SE-6 Gravel Bag Berm
- SE-8 Sandbag Barrier
- SE-14 Biofilter Bags



- Sediment removal may be inadequate to prevent sediment discharges in high flow conditions or if runoff is heavily sediment laden. If high flow conditions are expected, use other onsite sediment trapping techniques in conjunction with inlet protection.
- Frequent maintenance is required.
- Limit drainage area to 1 acre maximum. For drainage areas larger than 1 acre, runoff should be routed to a sediment-trapping device designed for larger flows. See BMPs SE-2, Sediment Basin, and SE-3, Sediment Traps.
- Excavated drop inlet sediment traps are appropriate where relatively heavy flows are expected, and overflow capability is needed.

## Implementation

### General

Inlet control measures presented in this handbook should not be used for inlets draining more than one acre. Runoff from larger disturbed areas should be first routed through SE-2, Sediment Basin or SE-3, Sediment Trap and/or used in conjunction with other drainage control, erosion control, and sediment control BMPs to protect the site. Different types of inlet protection are appropriate for different applications depending on site conditions and the type of inlet. Alternative methods are available in addition to the methods described/shown herein such as prefabricated inlet insert devices, or gutter protection devices.

### Design and Layout

Identify existing and planned storm drain inlets that have the potential to receive sediment-laden surface runoff. Determine if storm drain inlet protection is needed and which method to use.

- The key to successful and safe use of storm drain inlet protection devices is to know where runoff that is directed toward the inlet to be protected will pond or be diverted as a result of installing the protection device.
  - Determine the acceptable location and extent of ponding in the vicinity of the drain inlet. The acceptable location and extent of ponding will influence the type and design of the storm drain inlet protection device.
  - Determine the extent of potential runoff diversion caused by the storm drain inlet protection device. Runoff ponded by inlet protection devices may flow around the device and towards the next downstream inlet. In some cases, this is acceptable; in other cases, serious erosion or downstream property damage can be caused by these diversions. The possibility of runoff diversions will influence whether or not storm drain inlet protection is suitable; and, if suitable, the type and design of the device.
- The location and extent of ponding, and the extent of diversion, can usually be controlled through appropriate placement of the inlet protection device. In some cases, moving the inlet protection device a short distance upstream of the actual inlet can provide more efficient sediment control, limit ponding to desired areas, and prevent or control diversions.

- Six types of inlet protection are presented below. However, it is recognized that other effective methods and proprietary devices exist and may be selected.
  - Silt Fence: Appropriate for drainage basins with less than a 5% slope, sheet flows, and flows under 0.5 cfs.
  - Excavated Drop Inlet Sediment Trap: An excavated area around the inlet to trap sediment (SE-3).
  - Gravel bag barrier: Used to create a small sediment trap upstream of inlets on sloped, paved streets. Appropriate for sheet flow or when concentrated flow may exceed 0.5 cfs, and where overtopping is required to prevent flooding.
  - Block and Gravel Filter: Appropriate for flows greater than 0.5 cfs.
  - Temporary Geotextile Storm drain Inserts: Different products provide different features. Refer to manufacturer details for targeted pollutants and additional features.
  - Biofilter Bag Barrier: Used to create a small retention area upstream of inlets and can be located on pavement or soil. Biofilter bags slowly filter runoff allowing sediment to settle out. Appropriate for flows under 0.5 cfs.
- Select the appropriate type of inlet protection and design as referred to or as described in this fact sheet.
- Provide area around the inlet for water to pond without flooding structures and property.
- Grates and spaces around all inlets should be sealed to prevent seepage of sediment-laden water.
- Excavate sediment sumps (where needed) 1 to 2 ft with 2:1 side slopes around the inlet.

## **Installation**

- **DI Protection Type 1 - Silt Fence** - Similar to constructing a silt fence; see BMP SE-1, Silt Fence. Do not place fabric underneath the inlet grate since the collected sediment may fall into the drain inlet when the fabric is removed or replaced and water flow through the grate will be blocked resulting in flooding. See typical Type 1 installation details at the end of this fact sheet.
  1. Excavate a trench approximately 6 in. wide and 6 in. deep along the line of the silt fence inlet protection device.
  2. Place 2 in. by 2 in. wooden stakes around the perimeter of the inlet a maximum of 3 ft apart and drive them at least 18 in. into the ground or 12 in. below the bottom of the trench. The stakes should be at least 48 in.
  3. Lay fabric along bottom of trench, up side of trench, and then up stakes. See SE-1, Silt Fence, for details. The maximum silt fence height around the inlet is 24 in.
  4. Staple the filter fabric (for materials and specifications, see SE-1, Silt Fence) to wooden stakes. Use heavy-duty wire staples at least 1 in. in length.

5. Backfill the trench with gravel or compacted earth all the way around.
- **DI Protection Type 2 - Excavated Drop Inlet Sediment Trap** - Install filter fabric fence in accordance with DI Protection Type 1. Size excavated trap to provide a minimum storage capacity calculated at the rate 67 yd<sup>3</sup>/acre of drainage area. See typical Type 2 installation details at the end of this fact sheet.
  - **DI Protection Type 3 - Gravel bag** - Flow from a severe storm should not overtop the curb. In areas of high clay and silts, use filter fabric and gravel as additional filter media. Construct gravel bags in accordance with SE-6, Gravel Bag Berm. Gravel bags should be used due to their high permeability. See typical Type 3 installation details at the end of this fact sheet.
    1. Construct on gently sloping street.
    2. Leave room upstream of barrier for water to pond and sediment to settle.
    3. Place several layers of gravel bags – overlapping the bags and packing them tightly together.
    4. Leave gap of one bag on the top row to serve as a spillway. Flow from a severe storm (e.g., 10 year storm) should not overtop the curb.
  - **DI Protection Type 4 – Block and Gravel Filter** - Block and gravel filters are suitable for curb inlets commonly used in residential, commercial, and industrial construction. See typical Type 4 installation details at the end of this fact sheet.
    1. Place hardware cloth or comparable wire mesh with 0.5 in. openings over the drop inlet so that the wire extends a minimum of 1 ft beyond each side of the inlet structure. If more than one strip is necessary, overlap the strips. Place woven geotextile over the wire mesh.
    2. Place concrete blocks lengthwise on their sides in a single row around the perimeter of the inlet, so that the open ends face outward, not upward. The ends of adjacent blocks should abut. The height of the barrier can be varied, depending on design needs, by stacking combinations of blocks that are 4 in., 8 in., and 12 in. wide. The row of blocks should be at least 12 in. but no greater than 24 in. high.
    3. Place wire mesh over the outside vertical face (open end) of the concrete blocks to prevent stone from being washed through the blocks. Use hardware cloth or comparable wire mesh with 0.5 in. opening.
    4. Pile washed stone against the wire mesh to the top of the blocks. Use 0.75 to 3 in.
  - **DI Protection Type 5 – Temporary Geotextile Insert (proprietary)** – Many types of temporary inserts are available. Most inserts fit underneath the grate of a drop inlet or inside of a curb inlet and are fastened to the outside of the grate or curb. These inserts are removable and many can be cleaned and reused. Installation of these inserts differs between manufacturers. Please refer to manufacturer instruction for installation of proprietary devices.

- **DI Protection Type 6 - Biofilter bags** – Biofilter bags may be used as a substitute for gravel bags in low-flow situations. Biofilter bags should conform to specifications detailed in SE-14, Biofilter bags.
  1. Construct in a gently sloping area.
  2. Biofilter bags should be placed around inlets to intercept runoff flows.
  3. All bag joints should overlap by 6 in.
  4. Leave room upstream for water to pond and for sediment to settle out.
  5. Stake bags to the ground as described in the following detail. Stakes may be omitted if bags are placed on a paved surface.

## Costs

- Average annual cost for installation and maintenance of DI Type 1-4 and 6 (one year useful life) is \$200 per inlet.
- Temporary geotextile inserts are proprietary and cost varies by region. These inserts can often be reused and may have greater than 1 year of use if maintained and kept undamaged. Average cost per insert ranges from \$50-75 plus installation, but costs can exceed \$100. This cost does not include maintenance.

## Inspection and Maintenance

- BMPs must be inspected in accordance with General Permit requirements for the associated project type and risk level. It is recommended that at a minimum, BMPs be inspected weekly, prior to forecasted rain events, daily during extended rain events, and after the conclusion of rain events.
- Silt Fences. If the fabric becomes clogged, torn, or degrades, it should be replaced. Make sure the stakes are securely driven in the ground and are in good shape (i.e., not bent, cracked, or splintered, and are reasonably perpendicular to the ground). Replace damaged stakes. At a minimum, remove the sediment behind the fabric fence when accumulation reaches one-third the height of the fence or barrier height.
- Gravel Filters. If the gravel becomes clogged with sediment, it should be carefully removed from the inlet and either cleaned or replaced. Since cleaning gravel at a construction site may be difficult, consider using the sediment-laden stone as fill material and put fresh stone around the inlet. Inspect bags for holes, gashes, and snags, and replace bags as needed. Check gravel bags for proper arrangement and displacement.
- Sediment that accumulates in the BMP should be periodically removed in order to maintain BMP effectiveness. Sediment should be removed when the sediment accumulation reaches one-third of the barrier height.
- Inspect and maintain temporary geotextile insert devices according to manufacturer's specifications.
- Remove storm drain inlet protection once the drainage area is stabilized.



- Clean and regrade area around the inlet and clean the inside of the storm drain inlet, as it should be free of sediment and debris at the time of final inspection.

## References

Stormwater Quality Handbooks - Construction Site Best Management Practices (BMPs) Manual, State of California Department of Transportation (Caltrans), March 2003.

Stormwater Management Manual for The Puget Sound Basin, Washington State Department of Ecology, Public Review Draft, 1991.

Erosion and Sediment Control Manual, Oregon Department of Environmental Quality, February 2005.

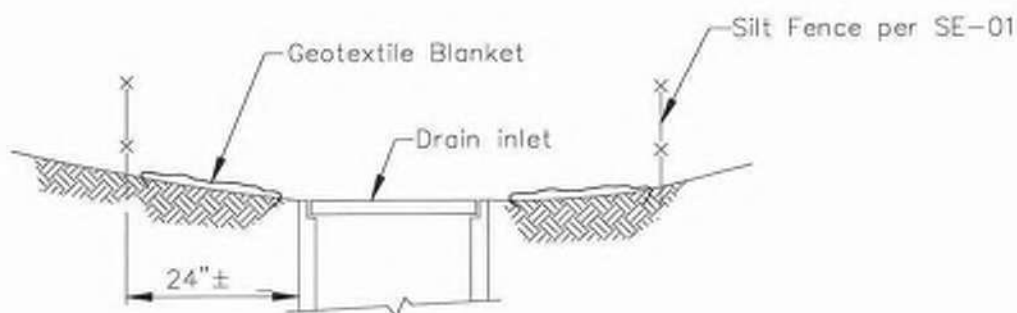

SECTION A-A

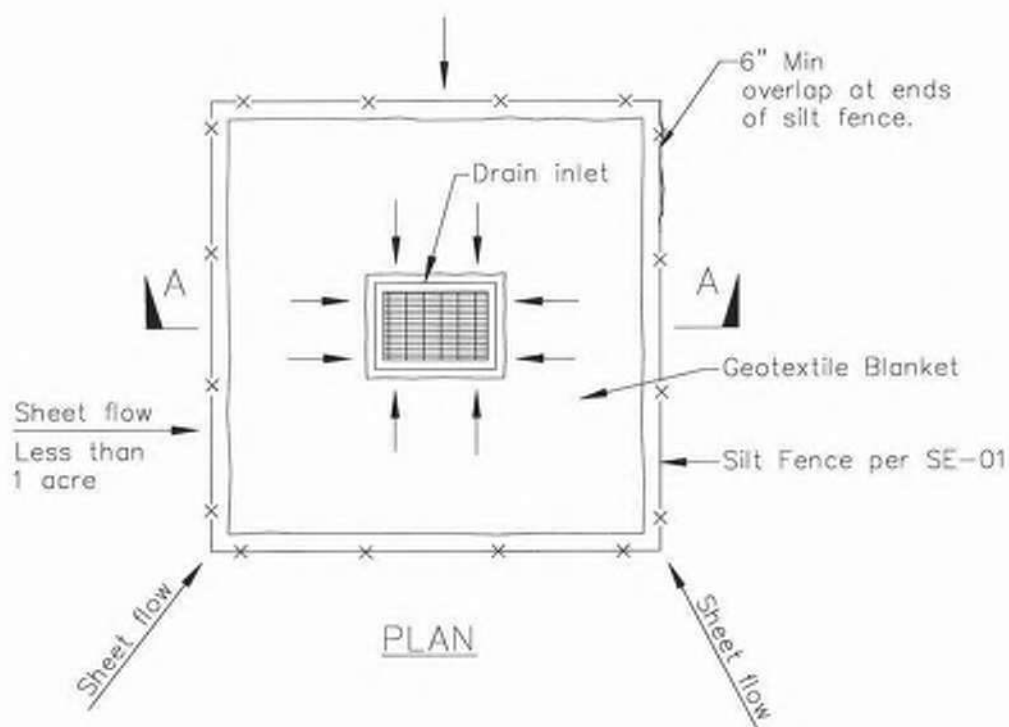

PLAN

DI PROTECTION TYPE 1  
NOT TO SCALE

NOTES:

1. For use in areas where grading has been completed and final soil stabilization and seeding are pending.
2. Not applicable in paved areas.
3. Not applicable with concentrated flows.

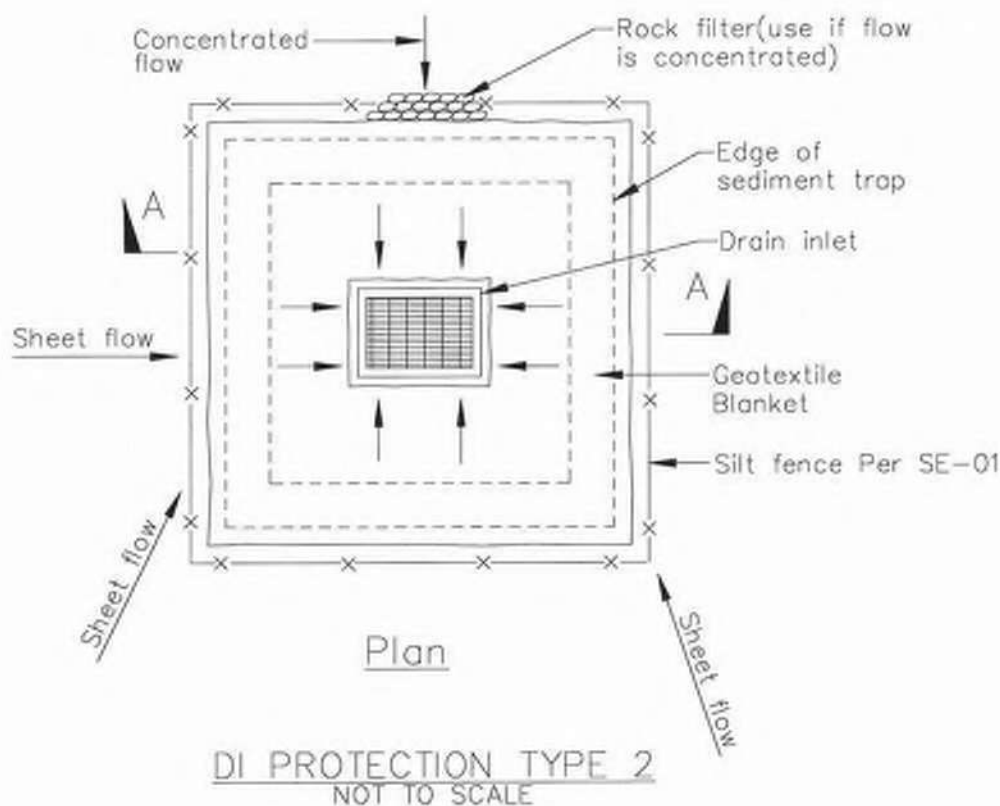
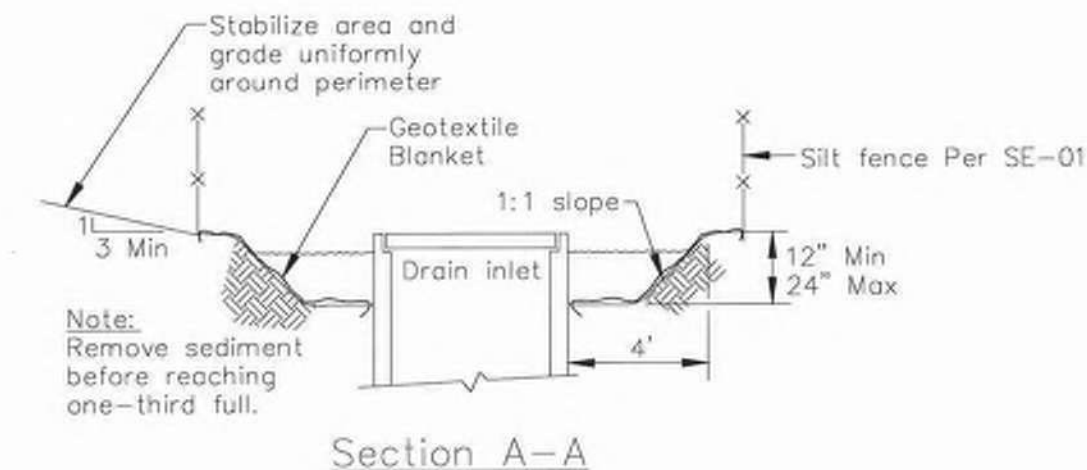

### Notes

1. For use in cleared and grubbed and in graded areas.
2. Shape basin so that longest inflow area faces longest length of trap.
3. For concentrated flows, shape basin in 2:1 ratio with length oriented towards direction of flow.

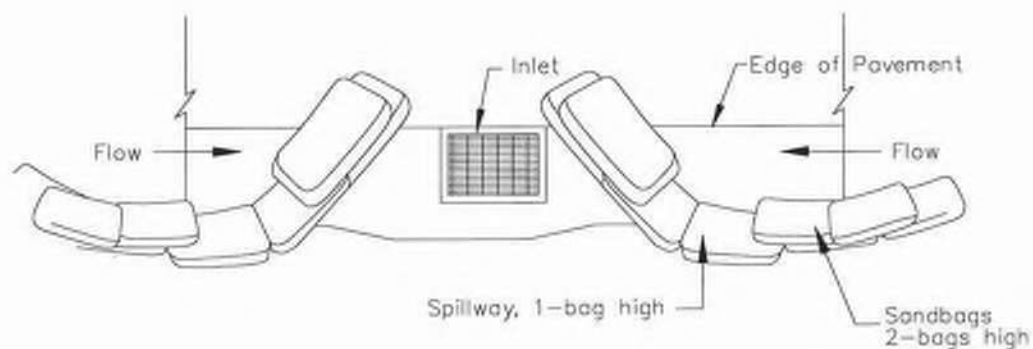

TYPICAL PROTECTION FOR INLET ON SUMP

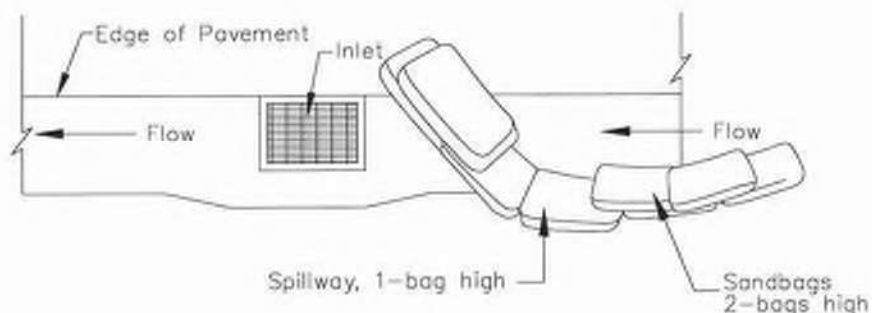

TYPICAL PROTECTION FOR INLET ON GRADE

NOTES:

1. Intended for short-term use.
2. Use to inhibit non-storm water flow.
3. Allow for proper maintenance and cleanup.
4. Bags must be removed after adjacent operation is completed
5. Not applicable in areas with high silts and clays without filter fabric.

DI PROTECTION TYPE 3  
NOT TO SCALE

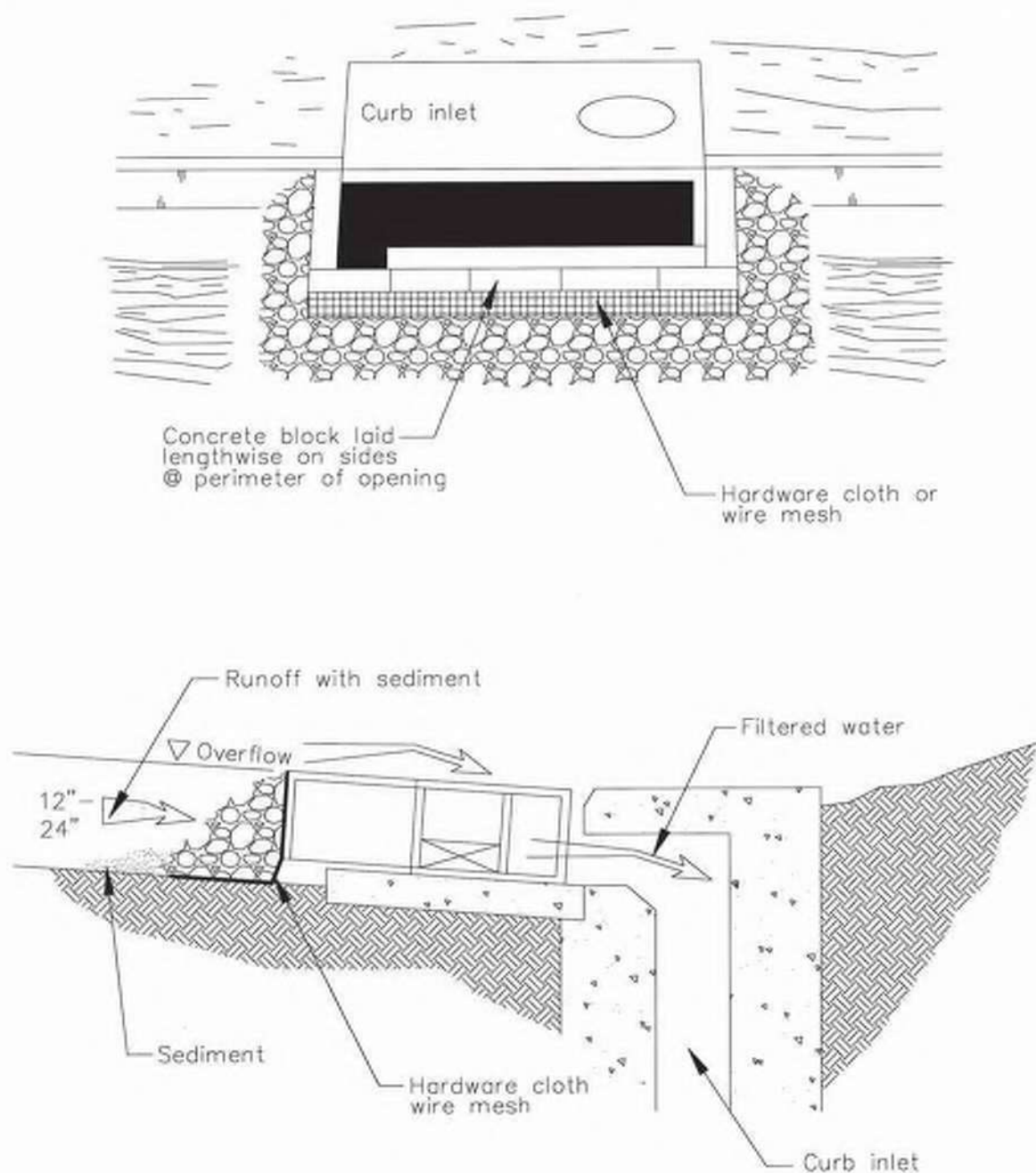

DI PROTECTION – TYPE 4  
NOT TO SCALE

## Description

Drain inserts are manufactured filters or fabric placed in a drop inlet to remove sediment and debris. There are a multitude of inserts of various shapes and configurations, typically falling into one of three different groups: socks, boxes, and trays. The sock consists of a fabric, usually constructed of polypropylene. The fabric may be attached to a frame or the grate of the inlet holds the sock. Socks are meant for vertical (drop) inlets. Boxes are constructed of plastic or wire mesh. Typically a polypropylene "bag" is placed in the wire mesh box. The bag takes the form of the box. Most box products are one box; that is, the setting area and filtration through media occur in the same box. Some products consist of one or more trays or mesh grates. The trays may hold different types of media. Filtration media vary by manufacturer. Types include polypropylene, porous polymer, treated cellulose, and activated carbon.

## California Experience

The number of installations is unknown but likely exceeds a thousand. Some users have reported that these systems require considerable maintenance to prevent plugging and bypass.

## Advantages

- Does not require additional space as inserts as the drain inlets are already a component of the standard drainage systems.
- Easy access for inspection and maintenance.
- As there is no standing water, there is little concern for mosquito breeding.
- A relatively inexpensive retrofit option.

## Limitations

Performance is likely significantly less than treatment systems that are located at the end of the drainage system such as ponds and vaults. Usually not suitable for large areas or areas with trash or leaves than can plug the insert.

## Design and Sizing Guidelines

Refer to manufacturer's guidelines. Drain inserts come any many configurations but can be placed into three general groups: socks, boxes, and trays. The sock consists of a fabric, usually constructed of polypropylene. The fabric may be attached to a frame or the grate of the inlet holds the sock. Socks are meant for vertical (drop) inlets. Boxes are constructed of plastic or wire mesh. Typically a polypropylene "bag" is placed in the wire mesh box. The bag takes the form of the box. Most box products are

## Design Considerations

- Use with other BMPs
- Fit and Seal Capacity within Inlet

## Targeted Constituents

- ✓ Sediment
- ✓ Nutrients
- ✓ Trash
- ✓ Metals
- ✓ Bacteria
- ✓ Oil and Grease
- ✓ Organics

### Removal Effectiveness

See New Development and Redevelopment Handbook-Section 5.



one box; that is, the setting area and filtration through media occurs in the same box. One manufacturer has a double-box. Stormwater enters the first box where setting occurs. The stormwater flows into the second box where the filter media is located. Some products consist of one or more trays or mesh grates. The trays can hold different types of media. Filtration media vary with the manufacturer: types include polypropylene, porous polymer, treated cellulose, and activated carbon.

**Construction/Inspection Considerations**

Be certain that installation is done in a manner that makes certain that the stormwater enters the unit and does not leak around the perimeter. Leakage between the frame of the insert and the frame of the drain inlet can easily occur with vertical (drop) inlets.

**Performance**

Few products have performance data collected under field conditions.

**Siting Criteria**

It is recommended that inserts be used only for retrofit situations or as pretreatment where other treatment BMPs presented in this section area used.

**Additional Design Guidelines**

Follow guidelines provided by individual manufacturers.

**Maintenance**

Likely require frequent maintenance, on the order of several times per year.

**Cost**

- The initial cost of individual inserts ranges from less than \$100 to about \$2,000. The cost of using multiple units in curb inlet drains varies with the size of the inlet.
- The low cost of inserts may tend to favor the use of these systems over other, more effective treatment BMPs. However, the low cost of each unit may be offset by the number of units that are required, more frequent maintenance, and the shorter structural life (and therefore replacement).

**References and Sources of Additional Information**

Hrachovec, R., and G. Minton, 2001, Field testing of a sock-type catch basin insert, Planet CPR, Seattle, Washington

Interagency Catch Basin Insert Committee, Evaluation of Commercially-Available Catch Basin Inserts for the Treatment of Stormwater Runoff from Developed Sites, 1995

Larry Walker Associates, June 1998, NDMP Inlet/In-Line Control Measure Study Report

Manufacturers literature

Santa Monica (City), Santa Monica Bay Municipal Stormwater/Urban Runoff Project - Evaluation of Potential Catch basin Retrofits, Woodward Clyde, September 24, 1998

Woodward Clyde, June 11, 1996, Parking Lot Monitoring Report, Santa Clara Valley Nonpoint Source Pollution Control Program.





## Design Considerations

- Soil for Infiltration
- Slope
- Aesthetics

## Description

An infiltration basin is a shallow impoundment that is designed to infiltrate stormwater. Infiltration basins use the natural filtering ability of the soil to remove pollutants in stormwater runoff. Infiltration facilities store runoff until it gradually exfiltrates through the soil and eventually into the water table. This practice has high pollutant removal efficiency and can also help recharge groundwater, thus helping to maintain low flows in stream systems. Infiltration basins can be challenging to apply on many sites, however, because of soils requirements. In addition, some studies have shown relatively high failure rates compared with other management practices.

## California Experience

Infiltration basins have a long history of use in California, especially in the Central Valley. Basins located in Fresno were among those initially evaluated in the National Urban Runoff Program and were found to be effective at reducing the volume of runoff, while posing little long-term threat to groundwater quality (EPA, 1983; Schroeder, 1995). Proper siting of these devices is crucial as underscored by the experience of Caltrans in siting two basins in Southern California. The basin with marginal separation from groundwater and soil permeability failed immediately and could never be rehabilitated.

## Advantages

- Provides 100% reduction in the load discharged to surface waters.
- The principal benefit of infiltration basins is the approximation of pre-development hydrology during which a

## Targeted Constituents

<input checked="" type="checkbox"/>	Sediment	■
<input checked="" type="checkbox"/>	Nutrients	■
<input checked="" type="checkbox"/>	Trash	■
<input checked="" type="checkbox"/>	Metals	■
<input checked="" type="checkbox"/>	Bacteria	■
<input checked="" type="checkbox"/>	Oil and Grease	■
<input checked="" type="checkbox"/>	Organics	■

## Legend (Removal Effectiveness)

- Low
- High
- ▲ Medium



significant portion of the average annual rainfall runoff is infiltrated and evaporated rather than flushed directly to creeks.

- If the water quality volume is adequately sized, infiltration basins can be useful for providing control of channel forming (erosion) and high frequency (generally less than the 2-year) flood events.

**Limitations**

- May not be appropriate for industrial sites or locations where spills may occur.
- Infiltration basins require a minimum soil infiltration rate of 0.5 inches/hour, not appropriate at sites with Hydrologic Soil Types C and D.
- If infiltration rates exceed 2.4 inches/hour, then the runoff should be fully treated prior to infiltration to protect groundwater quality.
- Not suitable on fill sites or steep slopes.
- Risk of groundwater contamination in very coarse soils.
- Upstream drainage area must be completely stabilized before construction.
- Difficult to restore functioning of infiltration basins once clogged.

**Design and Sizing Guidelines**

- Water quality volume determined by local requirements or sized so that 85% of the annual runoff volume is captured.
- Basin sized so that the entire water quality volume is infiltrated within 48 hours.
- Vegetation establishment on the basin floor may help reduce the clogging rate.

**Construction/Inspection Considerations**

- Before construction begins, stabilize the entire area draining to the facility. If impossible, place a diversion berm around the perimeter of the infiltration site to prevent sediment entrance during construction or remove the top 2 inches of soil after the site is stabilized. Stabilize the entire contributing drainage area, including the side slopes, before allowing any runoff to enter once construction is complete.
- Place excavated material such that it can not be washed back into the basin if a storm occurs during construction of the facility.
- Build the basin without driving heavy equipment over the infiltration surface. Any equipment driven on the surface should have extra-wide ("low pressure") tires. Prior to any construction, rope off the infiltration area to stop entrance by unwanted equipment.
- After final grading, till the infiltration surface deeply.
- Use appropriate erosion control seed mix for the specific project and location.

## Performance

As water migrates through porous soil and rock, pollutant attenuation mechanisms include precipitation, sorption, physical filtration, and bacterial degradation. If functioning properly, this approach is presumed to have high removal efficiencies for particulate pollutants and moderate removal of soluble pollutants. Actual pollutant removal in the subsurface would be expected to vary depending upon site-specific soil types. This technology eliminates discharge to surface waters except for the very largest storms; consequently, complete removal of all stormwater constituents can be assumed.

There remain some concerns about the potential for groundwater contamination despite the findings of the NURP and Nightingale (1975; 1987a,b,c; 1989). For instance, a report by Pitt et al. (1994) highlighted the potential for groundwater contamination from intentional and unintentional stormwater infiltration. That report recommends that infiltration facilities not be sited in areas where high concentrations are present or where there is a potential for spills of toxic material. Conversely, Schroeder (1995) reported that there was no evidence of groundwater impacts from an infiltration basin serving a large industrial catchment in Fresno, CA.

## Siting Criteria

The key element in siting infiltration basins is identifying sites with appropriate soil and hydrogeologic properties, which is critical for long term performance. In one study conducted in Prince George's County, Maryland (Galli, 1992), all of the infiltration basins investigated clogged within 2 years. It is believed that these failures were for the most part due to allowing infiltration at sites with rates of less than 0.5 in/hr, basing siting on soil type rather than field infiltration tests, and poor construction practices that resulted in soil compaction of the basin invert.

A study of 23 infiltration basins in the Pacific Northwest showed better long-term performance in an area with highly permeable soils (Hilding, 1996). In this study, few of the infiltration basins had failed after 10 years. Consequently, the following guidelines for identifying appropriate soil and subsurface conditions should be rigorously adhered to.

- Determine soil type (consider RCS soil type 'A, B or C' only) from mapping and consult USDA soil survey tables to review other parameters such as the amount of silt and clay, presence of a restrictive layer or seasonal high water table, and estimated permeability. The soil should not have more than 30% clay or more than 40% of clay and silt combined. Eliminate sites that are clearly unsuitable for infiltration.
- Groundwater separation should be at least 3 m from the basin invert to the measured ground water elevation. There is concern at the state and regional levels of the impact on groundwater quality from infiltrated runoff, especially when the separation between groundwater and the surface is small.
- Location away from buildings, slopes and highway pavement (greater than 6 m) and wells and bridge structures (greater than 30 m). Sites constructed of fill, having a base flow or with a slope greater than 15% should not be considered.
- Ensure that adequate head is available to operate flow splitter structures (to allow the basin to be offline) without ponding in the splitter structure or creating backwater upstream of the splitter.

- Base flow should not be present in the tributary watershed.

### **Secondary Screening Based on Site Geotechnical Investigation**

- At least three in-hole conductivity tests shall be performed using USBR 7300-89 or Bouwer-Rice procedures (the latter if groundwater is encountered within the boring), two tests at different locations within the proposed basin and the third down gradient by no more than approximately 10 m. The tests shall measure permeability in the side slopes and the bed within a depth of 3 m of the invert.
- The minimum acceptable hydraulic conductivity as measured in any of the three required test holes is 13 mm/hr. If any test hole shows less than the minimum value, the site should be disqualified from further consideration.
- Exclude from consideration sites constructed in fill or partially in fill unless no silts or clays are present in the soil boring. Fill tends to be compacted, with clays in a dispersed rather than flocculated state, greatly reducing permeability.
- The geotechnical investigation should be such that a good understanding is gained as to how the stormwater runoff will move in the soil (horizontally or vertically) and if there are any geological conditions that could inhibit the movement of water.

### **Additional Design Guidelines**

- (1) Basin Sizing - The required water quality volume is determined by local regulations or sufficient to capture 85% of the annual runoff.
- (2) Provide pretreatment if sediment loading is a maintenance concern for the basin.
- (3) Include energy dissipation in the inlet design for the basins. Avoid designs that include a permanent pool to reduce opportunity for standing water and associated vector problems.
- (4) Basin invert area should be determined by the equation:

$$A = \frac{WQV}{kt}$$

where A = Basin invert area (m<sup>2</sup>)

WQV = water quality volume (m<sup>3</sup>)

k = 0.5 times the lowest field-measured hydraulic conductivity (m/hr)

t = drawdown time ( 48 hr)

- (5) The use of vertical piping, either for distribution or infiltration enhancement shall not be allowed to avoid device classification as a Class V injection well per 40 CFR146.5(e)(4).

## Maintenance

Regular maintenance is critical to the successful operation of infiltration basins. Recommended operation and maintenance guidelines include:

- Inspections and maintenance to ensure that water infiltrates into the subsurface completely (recommended infiltration rate of 72 hours or less) and that vegetation is carefully managed to prevent creating mosquito and other vector habitats.
- Observe drain time for the design storm after completion or modification of the facility to confirm that the desired drain time has been obtained.
- Schedule semiannual inspections for beginning and end of the wet season to identify potential problems such as erosion of the basin side slopes and invert, standing water, trash and debris, and sediment accumulation.
- Remove accumulated trash and debris in the basin at the start and end of the wet season.
- Inspect for standing water at the end of the wet season.
- Trim vegetation at the beginning and end of the wet season to prevent establishment of woody vegetation and for aesthetic and vector reasons.
- Remove accumulated sediment and regrade when the accumulated sediment volume exceeds 10% of the basin.
- If erosion is occurring within the basin, revegetate immediately and stabilize with an erosion control mulch or mat until vegetation cover is established.
- To avoid reversing soil development, scarification or other disturbance should only be performed when there are actual signs of clogging, rather than on a routine basis. Always remove deposited sediments before scarification, and use a hand-guided rotary tiller, if possible, or a disc harrow pulled by a very light tractor.

## Cost

Infiltration basins are relatively cost-effective practices because little infrastructure is needed when constructing them. One study estimated the total construction cost at about \$2 per ft (adjusted for inflation) of storage for a 0.25-acre basin (SWRPC, 1991). As with other BMPs, these published cost estimates may deviate greatly from what might be incurred at a specific site. For instance, Caltrans spent about \$18/ft<sup>3</sup> for the two infiltration basins constructed in southern California, each of which had a water quality volume of about 0.34 ac.-ft. Much of the higher cost can be attributed to changes in the storm drain system necessary to route the runoff to the basin locations.

Infiltration basins typically consume about 2 to 3% of the site draining to them, which is relatively small. Additional space may be required for buffer, landscaping, access road, and fencing. Maintenance costs are estimated at 5 to 10% of construction costs.

One cost concern associated with infiltration practices is the maintenance burden and longevity. If improperly maintained, infiltration basins have a high failure rate. Thus, it may be necessary to replace the basin with a different technology after a relatively short period of time.

**References and Sources of Additional Information**

- Caltrans, 2002, BMP Retrofit Pilot Program Proposed Final Report, Rpt. CTSW-RT-01-050, California Dept. of Transportation, Sacramento, CA.
- Galli, J. 1992. *Analysis of Urban BMP Performance and Longevity in Prince George's County, Maryland*. Metropolitan Washington Council of Governments, Washington, DC.
- Hilding, K. 1996. Longevity of infiltration basins assessed in Puget Sound. *Watershed Protection Techniques* 1(3):124–125.
- Maryland Department of the Environment (MDE). 2000. *Maryland Stormwater Design Manual*. <http://www.mde.state.md.us/environment/wma/stormwatermanual>. Accessed May 22, 2002.
- Metzger, M. E., D. F. Messer, C. L. Beitia, C. M. Myers, and V. L. Kramer. 2002. The Dark Side Of Stormwater Runoff Management: Disease Vectors Associated With Structural BMPs. *Stormwater* 3(2): 24-39.
- Nightingale, H.I., 1975, "Lead, Zinc, and Copper in Soils of Urban Storm-Runoff Retention Basins," *American Water Works Assoc. Journal*. Vol. 67, p. 443-446.
- Nightingale, H.I., 1987a, "Water Quality beneath Urban Runoff Water Management Basins," *Water Resources Bulletin*, Vol. 23, p. 197-205.
- Nightingale, H.I., 1987b, "Accumulation of As, Ni, Cu, and Pb in Retention and Recharge Basin Soils from Urban Runoff," *Water Resources Bulletin*, Vol. 23, p. 663-672.
- Nightingale, H.I., 1987c, "Organic Pollutants in Soils of Retention/Recharge Basins Receiving Urban Runoff Water," *Soil Science* Vol. 148, pp. 39-45.
- Nightingale, H.I., Harrison, D., and Salo, J.E., 1985, "An Evaluation Technique for Ground-water Quality Beneath Urban Runoff Retention and Percolation Basins," *Ground Water Monitoring Review*, Vol. 5, No. 1, pp. 43-50.
- Oberts, G. 1994. Performance of Stormwater Ponds and Wetlands in Winter. *Watershed Protection Techniques* 1(2): 64–68.
- Pitt, R., et al. 1994, *Potential Groundwater Contamination from Intentional and Nonintentional Stormwater Infiltration*, EPA/600/R-94/051, Risk Reduction Engineering Laboratory, U.S. EPA, Cincinnati, OH.
- Schueler, T. 1987. *Controlling Urban Runoff: A Practical Manual for Planning and Designing Urban BMPs*. Metropolitan Washington Council of Governments, Washington, DC.
- Schroeder, R.A., 1995, *Potential For Chemical Transport Beneath a Storm-Runoff Recharge (Retention) Basin for an Industrial Catchment in Fresno, CA*, USGS Water-Resource Investigations Report 93-4140.

Southeastern Wisconsin Regional Planning Commission (SWRPC). 1991. *Costs of Urban Nonpoint Source Water Pollution Control Measures*. Southeastern Wisconsin Regional Planning Commission, Waukesha, WI.

U.S. EPA, 1983, *Results of the Nationwide Urban Runoff Program: Volume 1 – Final Report*, WH-554, Water Planning Division, Washington, DC.

Watershed Management Institute (WMI). 1997. *Operation, Maintenance, and Management of Stormwater Management Systems*. Prepared for U.S. Environmental Protection Agency Office of Water, Washington, DC.

### **Information Resources**

Center for Watershed Protection (CWP). 1997. *Stormwater BMP Design Supplement for Cold Climates*. Prepared for U.S. Environmental Protection Agency Office of Wetlands, Oceans and Watersheds. Washington, DC.

Ferguson, B.K., 1994. *Stormwater Infiltration*. CRC Press, Ann Arbor, MI.

USEPA. 1993. *Guidance to Specify Management Measures for Sources of Nonpoint Pollution in Coastal Waters*. EPA-840-B-92-002. U.S. Environmental Protection Agency, Office of Water, Washington, DC.

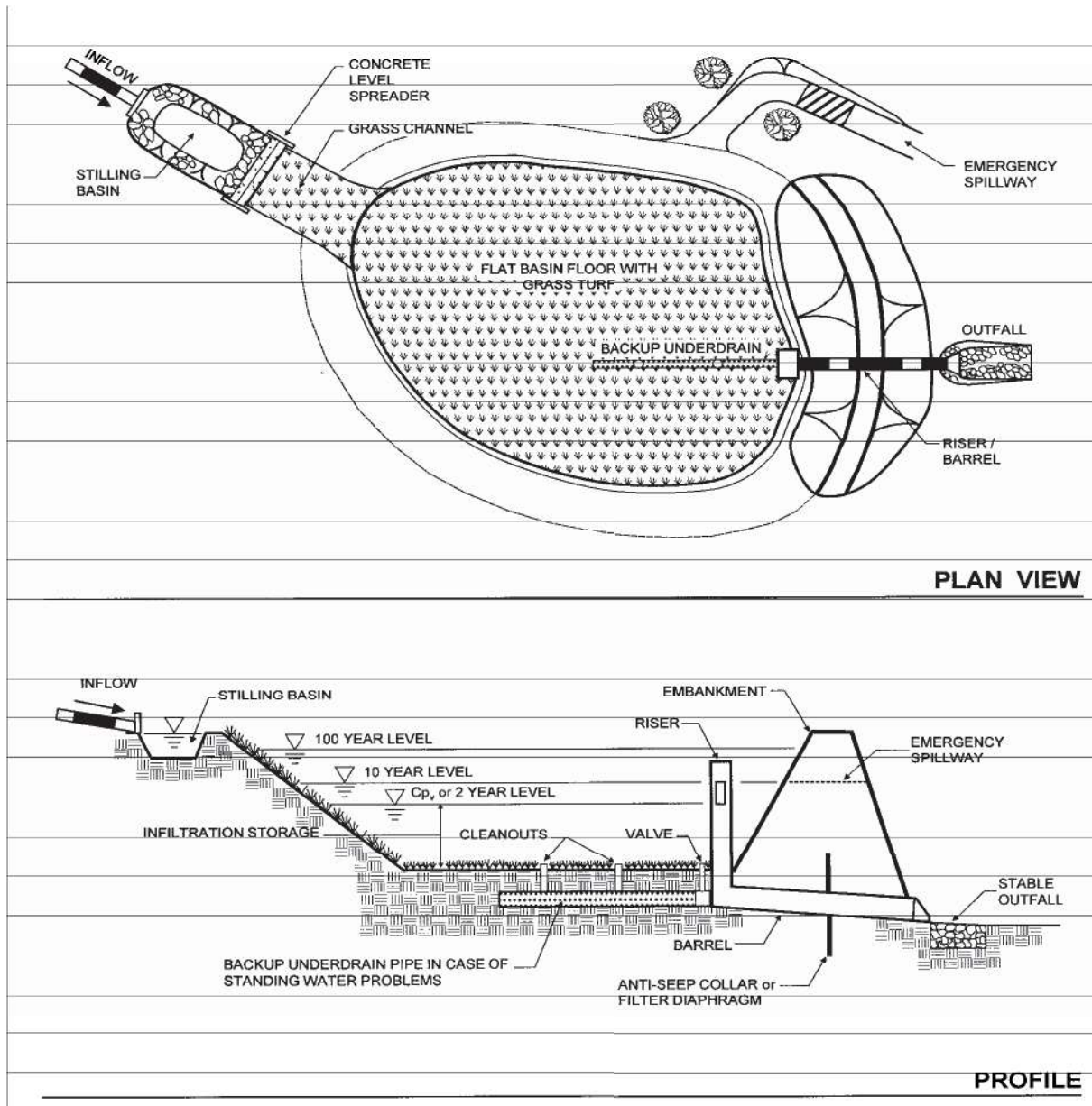



**XIV.1. Hydrologic Source Control Fact Sheets (HSC)**

HSC-1: Localized On-Lot Infiltration

‘Localized on-lot infiltration’ refers to the practice of collecting on-site runoff from small distributed areas within a catchment and diverting it to a dedicated on-site infiltration area. This technique can include disconnecting downspouts and draining sidewalks and patios into french drains, trenches, small rain gardens, or other surface depressions. For downspout disconnections and other impervious area disconnection involving dispersion over pervious surfaces, but without intentional ponding, see HSC-2: Impervious Area Dispersion.

<i>Also known as:</i>
<ul style="list-style-type: none"> <li>➤ <i>Downspout infiltration</i></li> <li>➤ <i>Retention grading</i></li> <li>➤ <i>French drains</i></li> <li>➤ <i>On-lot rain gardens</i></li> </ul>

<p>On-lot rain garden Source: <a href="http://lowimpactdevelopment.org">lowimpactdevelopment.org</a></p>

**Feasibility Screening Considerations**

- ‘Localized on-lot infiltration’ shall meet infiltration infeasibility screening criteria to be considered for use.

**Opportunity Criteria**

- Runoff can be directed to and temporarily pond in pervious area depressions, rock trenches, or similar.
- Soils are adequate for infiltration or can be amended to provide an adequate infiltration rate.
- Shallow utilities are not present below infiltration areas.

**OC-Specific Design Criteria and Considerations**

- A single on-lot infiltration area should not be sized to retain runoff from impervious areas greater than 4,000 sq. ft.; if the drainage area exceeds this criteria, sizing should be based on calculations for bioretention areas or infiltration trenches.
- Soils should be sufficiently permeable to eliminate ponded water within 24 hours following a 85<sup>th</sup> percentile, 24-hour storm event.
- Maximum ponding depth should be should be less than 3 inches and trench depth should be less than 1.5 feet.
- Infiltration should not be used when the depth to the mounded seasonally high table is within 5 feet of the bottom of infiltrating surface.
- Infiltration via depression storage, french drains, or rain gardens should be located greater than 8 feet from building foundations.
- Site slope should be less than 10%.
- Infiltration unit should not be located within 50 feet of slopes greater than 15 percent.
- Side slopes of rain garden or depression storage should not exceed 3H:1V.
- Effective energy dissipation and uniform flow spreading methods should be employed to prevent erosion resulting fromwater entering infiltration areas.

- Overflow should be located such that it does not cause erosion or and is conveyed away from structures toward the downstream conveyance and treatment system. .

**Calculating HSC Retention Volume**

- The retention volume provided by localized on-lot infiltration can be computed as the storage volume provided by surface ponding and the pore space within an amended soil layer or gravel trench.
- Estimate the average retention volume per 1000 square feet impervious tributary area provided by on-lot infiltration.
- Look up the storm retention depth,  $d_{HSC}$  from the chart to the right.
- The max  $d_{HSC}$  is equal to the design capture storm depth for the project site.

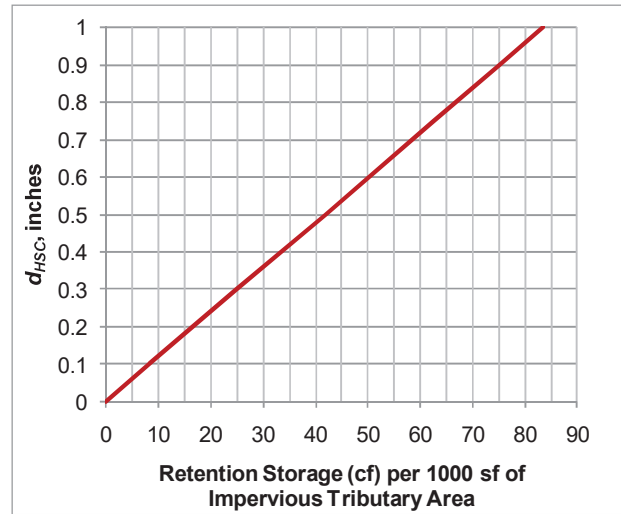

**Configuration for Use in a Treatment Train**

- Localized on-lot infiltration would typically serve as the first in a treatment train and should only be used where tributary areas do not generate significant sediment that would require pretreatment to mitigate clogging.
- The use of impervious area disconnection reduces the sizing requirement for downstream LID and/or conventional treatment control BMPs.

**Additional References for Design Guidance**

- LID Center – Rain Garden Design Template. [http://www.lowimpactdevelopment.org/raingarden\\_design/](http://www.lowimpactdevelopment.org/raingarden_design/)
- University of Wisconsin Extension. Rain Gardens: A How-To Manual for Homeowners. <http://learningstore.uwex.edu/assets/pdfs/GWQ037.pdf>

HSC-2: Impervious Area Dispersion

Impervious area dispersion refers to the practice of routing runoff from impervious areas, such as rooftops, walkways, and patios onto the surface of adjacent pervious areas. Runoff is dispersed uniformly via splash block or dispersion trench and soaks into the ground as it move slowly across the surface of pervious areas. Minor ponding may occur, but it is not the intent of this practice to actively promote localized on-lot storage (See HSC-1: Localized On-Lot Infiltration).

- Also known as:**
- Downspout disconnection
  - Impervious area disconnection
  - Sheet flow dispersion

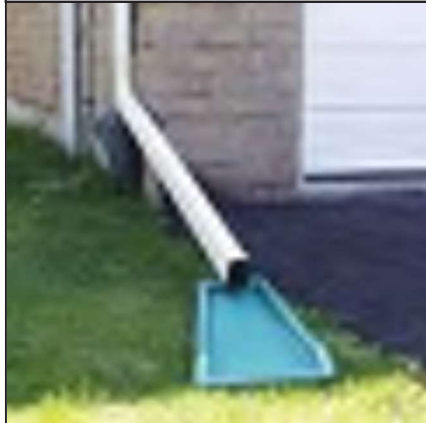

Simple Downspout Dispersion  
 Source:  
[toronto.ca/environment/water.htm](http://toronto.ca/environment/water.htm)

**Feasibility Screening Considerations**

- Impervious area dispersion can be used where infiltration would otherwise be infeasible, however dispersion depth over landscaped areas should be limited by site-specific conditions to prevent standing water or geotechnical issues.

**Opportunity Criteria**

- Rooftops and other low traffic impervious surface present in drainage area.
- Soils are adequate for infiltration. If not, soils can be amended to improve capacity to absorb dispersed water (see MISC-2: Amended Soils).
- Significant pervious area present in drainage area with shallow slope
- Overflow from pervious area can be safely managed.

**OC-Specific Design Criteria and Considerations**

- Soils should be preserved from their natural condition or restored via soil amendments to meet minimum criteria described in Section .
- A minimum of 1 part pervious area capable of receiving flow should be provided for every 2 parts of impervious area disconnected.
- The pervious area receiving flow should have a slope  $\leq 2$  percent and path lengths of  $\geq 20$  feet per 1000 sf of impervious area.
- Dispersion areas should be maintained to remove trash and debris, loose vegetation, and protect any areas of bare soil from erosion.
- Velocity of dispersed flow should not be greater than 0.5 ft per second to avoid scour.

**Calculating HSC Retention Volume**

- The retention volume provided by downspout dispersion is a function of the ratio of impervious to pervious area and the condition of soils in the pervious area.
- Determine flow patterns in pervious area and estimate footprint of pervious area receiving dispersed flow. Calculate the ratio of pervious to impervious area.
- Check soil conditions using the soil condition design criteria below; amend if necessary.
- Look up the storm retention depth,  $d_{HSC}$  from the chart below.

- The max  $d_{HSC}$  is equal to the design storm depth for the project site.

**Soil Condition Design Criteria**

- Maximum slope of 2 percent
- Well-established lawn or landscaping
- Minimum soil amendments per criteria in MISC-2: Amended Soils.

**Configuration for Use in a Treatment Train**

- Impervious area disconnection is an HSC that may be used as the first element in any treatment train
- The use of impervious area disconnection reduces the sizing requirement for downstream LID and/or treatment control BMPs

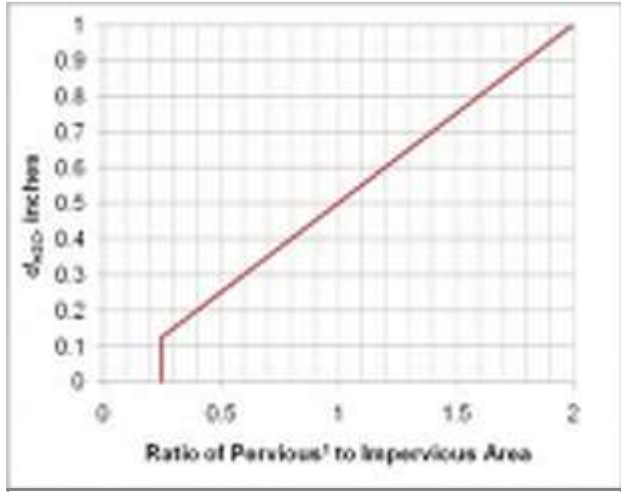

<sup>1</sup> Pervious area used in calculation should only include the pervious area receiving flow, not pervious area receiving only direct rainfall or upslope pervious drainage.

**Additional References for Design Guidance**

- SMC LID Manual (pp 131)  
[http://www.lowimpactdevelopment.org/guest75/pub/All\\_Projects/SoCal\\_LID\\_Manual/SoCalLID\\_Manual\\_FINAL\\_040910.pdf](http://www.lowimpactdevelopment.org/guest75/pub/All_Projects/SoCal_LID_Manual/SoCalLID_Manual_FINAL_040910.pdf)
- City of Portland Bureau of Environmental Services. 2010. How to manage stormwater – Disconnect Downspouts. <http://www.portlandonline.com/bes/index.cfm?c=43081&a=177702>
- Seattle Public Utility:  
[http://www.cityofseattle.org/util/stellent/groups/public/@spu/@usm/documents/webcontent/spu01\\_006395.pdf](http://www.cityofseattle.org/util/stellent/groups/public/@spu/@usm/documents/webcontent/spu01_006395.pdf)
- Thurston County, Washington State (pp 10):  
[http://www.co.thurston.wa.us/stormwater/manual/docs-faqs/DG-5-Roof-Runoff-Control\\_Rev11Jan24.pdf](http://www.co.thurston.wa.us/stormwater/manual/docs-faqs/DG-5-Roof-Runoff-Control_Rev11Jan24.pdf)

HSC-3: Street Trees

By intercepting rainfall, trees can provide several aesthetic and stormwater benefits including peak flow control, increased infiltration and ET, and runoff temperature reduction. The volume of precipitation intercepted by the canopy reduces the treatment volume required for downstream treatment BMPs. Shading reduces the heat island effect as well as the temperature of adjacent impervious surfaces, over which stormwater flows, and thus reduces the heat transferred to downstream receiving waters. Tree roots also strengthen the soil structure and provide infiltrative pathways, simultaneously reducing erosion potential and enhancing infiltration.

<i>Also known as:</i>
➤ <i>Canopy interception</i>

<p>Street trees Source: Geosyntec Consultants</p>

**Feasibility Screening Considerations**

- Not applicable

**Opportunity Criteria**

- Street trees can be incorporated in green streets designs along sidewalks, streets, parking lots, or driveways.
- Street trees can be used in combination with bioretention systems along medians or in traffic calming bays.
- There must be sufficient space available to accommodate both the tree canopy and root system.

**OC-Specific Design Criteria and Considerations**

- Mature tree canopy, height, and root system should not interfere with subsurface utilities, suspended powerlines, buildings and foundations, or other existing or planned structures. Required setbacks should be adhered to.
- Depending on space constraints, a 20 to 30 foot diameter canopy (at maturity) is recommended for stormwater mitigation.
- Native, drought-tolerant species should be selected in order to minimize irrigation requirements and improve the long-term viability of trees.
- Trees should not impede pedestrian or vehicle sight lines.
- Planting locations should receive adequate sunlight and wind protection; other environmental factors should be considered prior to planting.
- Frequency and degree of vegetation management and maintenance should be considered with respect to owner capabilities (e.g., staffing, funding, etc.).
- Soils should be preserved in their natural condition (if appropriate for planting) or restored via soil amendments to meet minimum criteria described in MISC-2: Amended Soils. If necessary, a landscape architect or plant biologist should be consulted.
- A street tree selection guide, such as that specific to the City of Los Angeles, may need to be consulted to select species appropriate for the site design constraints (e.g., parkway size, tree height, canopy spread, etc.)
- Infiltration should not cause geotechnical hazards related to adjacent structures (buildings,

roadways, sidewalks, utilities, etc.)

### **Calculating HSC Retention Volume**

---

- The retention volume provided by street trees via canopy interception is dependent on the tree species, time of the year, and maturity.
- To compute the retention depth, the expected impervious area covered by the full tree canopy after 4 years of growth must be computed ( $IA_{HSC}$ ). The maximum retention depth credit for canopy interception ( $d_{HSC}$ ) is 0.05 inches over the area covered by the canopy at 4 years of growth.

### **Configuration for Use in a Treatment Train**

---

- As a HSC, street trees would serve as the first step in a treatment train by reducing the treatment volume and flow rate of a downstream treatment BMP.

### **Additional References for Design Guidance**

---

- California Stormwater BMP Handbook.  
[http://www.cabmphandbooks.com/Documents/Development/Section\\_3.pdf](http://www.cabmphandbooks.com/Documents/Development/Section_3.pdf)
- City of Los Angeles, Street Tree Division - Street Tree Selection Guide.  
<http://bss.lacity.org/UrbanForestryDivision/StreetTreeSelectionGuide.htm>
- Portland Stormwater Management Manual.  
<http://www.portlandonline.com/bes/index.cfm?c=35122&a=55791>
- San Diego County – Low Impact Development Fact Sheets.  
<http://www.sdcounty.ca.gov/dplu/docs/LID-Appendices.pdf>

## TRAINING / EDUCATIONAL LOG

Date of Training/Educational Activity: \_\_\_\_\_

Name of Person Performing Activity  
(Printed): \_\_\_\_\_

Signature: \_\_\_\_\_

Topic of Training/Educational Activity: \_\_\_\_\_

\_\_\_\_\_

Name of Participant	Signature of Participant

For newsletter or mailer educational activities, please include the following information:

- **Date of mailing**
- **Number distributed**
- **Method of distribution**
- **Topics addressed**

If a newsletter article was distributed, please include a copy of it.

# Employee Training Self-Certification

Project Name: \_\_\_\_\_

Date: \_\_\_\_\_

Stormwater Quality Management Topic: (provide brief description of training)

\_\_\_\_\_

\_\_\_\_\_

\_\_\_\_\_

\_\_\_\_\_

\_\_\_\_\_

Course Length (hours): \_\_\_\_\_

## Certification:

Attendee Name: \_\_\_\_\_

Signature: \_\_\_\_\_

Date: \_\_\_\_\_





# A Citizen's Guide to Understanding Stormwater



EPA 833-B-03-002  
February 2003

EPA  
U.S. Environmental Protection Agency

or visit  
[www.epa.gov/pdes/stormwater](http://www.epa.gov/pdes/stormwater)  
[www.epa.gov/pds](http://www.epa.gov/pds)

For more information contact:

## After the Storm



### What is stormwater runoff?



Stormwater runoff occurs when precipitation from rain or snowmelt flows over the ground. Impervious surfaces like driveways, sidewalks, and streets prevent stormwater from naturally soaking into the ground.

### Why is stormwater runoff a problem?



Stormwater can pick up debris, chemicals, dirt, and other pollutants and flow into a storm sewer system or directly to a lake, stream, river, wetland, or coastal water. Anything that enters a storm sewer system is discharged untreated into the waterbodies we use for swimming, fishing, and providing drinking water.

### The effects of pollution

Polluted stormwater runoff can have many adverse effects on plants, fish, animals, and people.

- ◆ Sediment can cloud the water and make it difficult or impossible for aquatic plants to grow. Sediment also can destroy aquatic habitats.
- ◆ Excess nutrients can cause algae blooms. When algae die, they sink to the bottom and decompose in a process that removes oxygen from the water. Fish and other aquatic organisms can't exist in water with low dissolved oxygen levels.
- ◆ Bacteria and other pathogens can wash into swimming areas and create health hazards, often making beach closures necessary.
- ◆ Debris—plastic bags, six-pack rings, bottles, and cigarette butts—washed into waterbodies can choke, suffocate, or disable aquatic life like ducks, fish, turtles, and birds.
- ◆ Household hazardous wastes like insecticides, pesticides, paint, solvents, used motor oil, and other auto fluids can poison aquatic life. Land animals and people can become sick or die from eating diseased fish and shellfish or ingesting polluted water.



- ◆ Polluted stormwater often affects drinking water sources. This, in turn, can affect human health and increase drinking water treatment costs.



# Stormwater Pollution Solutions

## Auto care

Washing your car and degreasing auto parts at home can send detergents and other contaminants through the storm sewer system. Dumping automotive fluids into storm drains has the same result as dumping the materials directly into a waterbody.

- Use a commercial car wash that treats or recycles its wastewater or wash your car on your yard so the water infiltrates into the ground.
- Repair leaks and dispose of used auto fluids and batteries at designated drop-off or recycling locations.

*Recycle or properly dispose of household products that contain chemicals, such as detergents, pesticides, paint, solvents, and used motor oil and other auto fluids. Don't pour them onto the ground or into storm drains.*

## Lawn care

Excess fertilizers and pesticides applied to lawns and gardens wash off and pollute streams, in addition, yard clippings and leaves can wash into storm drains and contribute nutrients and organic matter to streams.

- Don't overwater your lawn. Consider using a soaker hose instead of a sprinkler.

- Use pesticides and fertilizers sparingly. When use is necessary, use these chemicals in the recommended amounts. Use organic mulch or safer pest control methods whenever possible.
- Compost or mulch yard waste. Don't leave it in the street or sweep it into storm drains or streams.
- Cover piles of dirt or mulch being used in landscaping projects.

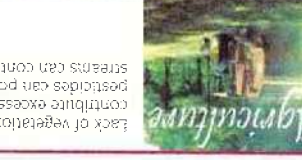

## Septic systems



Leaking and poorly maintained septic systems release nutrients and pathogens (bacteria and viruses) that can be picked up by stormwater and discharged into nearby waterbodies. Pathogens can cause public health problems and environmental concerns.

- Inspect your system every 3 years and pump your tank as necessary (every 3 to 5 years).
- Don't dispose of household hazardous waste in sinks or toilets.

## Pet waste



Pet waste can be a major source of bacteria and excess nutrients in local waters.

- When walking your pet, remember to pick up the waste and dispose of it properly. Flushing pet waste is the best disposal method. Leaving pet waste on the ground increases public health risks by allowing harmful bacteria and nutrients to wash into the storm drain and eventually into local waterbodies.
- Install silt fences, vehicle mud removal areas, vegetative cover, and other sediment and erosion controls, and properly maintain them, especially after rainstorms.
- Prevent soil erosion by minimizing disturbed areas during construction projects, and seed and mulch bare areas as soon as possible.

- Lack of vegetation on streambanks can lead to erosion. Overgrazed pastures can also contribute excessive amounts of sediment to local waterbodies. Excess fertilizers and pesticides can poison aquatic animals and lead to destructive algae blooms. Livestock in streams can contaminate waterways with bacteria, making them unsafe for human contact.
- Keep livestock away from streambanks and provide them a water source away from waterbodies.
- Store and apply fertilizer away from waterbodies and in accordance with a nutrient management plan.
- Vegetate riparian areas along waterways.
- Rotate animal grazing to prevent soil erosion in fields.
- Apply fertilizers and pesticides according to label instructions to save money and minimize pollution.

- Improperly managed logging operations can result in erosion and sedimentation.
- Conduct preharvest planning to prevent erosion and lower costs.
- Use logging methods and equipment that minimize soil disturbance.
- Plan and design skid trails, yard areas, and truck access roads to minimize stream crossings and avoid disturbing the forest floor.
- Construct stream crossings so that they minimize erosion and physical changes to streams.
- Expedite revegetation of cleared areas.

## Residential Landscaping

**Permeable Pavement**—Traditional concrete and asphalt don't allow water to soak into the ground. Instead these surfaces rely on storm drains to divert unwanted water. Permeable pavement systems allow rain and snowmelt to soak through, decreasing stormwater runoff.

**Rain Barrels**—You can collect rainwater from rooftops in mosquito-proof containers. The water can be used later on lawn or garden areas.

**Rain Gardens and Grass Swales**—Specially designed areas planted with native plants can provide natural places for rainwater to collect and soak into the ground. Rain from rooftop areas or paved areas can be diverted into these areas rather than into storm drains.

**Vegetated Filter Strips**—Filter strips are areas of native grass or plants created along roadways or storm drains. They trap the pollutants stormwater picks up as it flows across driveways and streets.

- Uncovered fueling stations allow spills to be washed into storm drains. Cars waiting to be repaired can leak fuel, oil, and other harmful fluids that can be picked up by stormwater.
- Clean up spills immediately and properly dispose of cleanup materials.
- Provide cover over fueling stations and design or retrofit facilities for spill containment.
- Properly maintain fleet vehicles to prevent oil, gas, and other discharges from being washed into local waterbodies.
- Install and maintain oil/water separators.

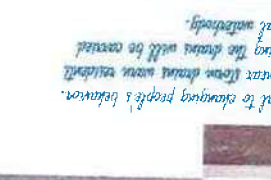
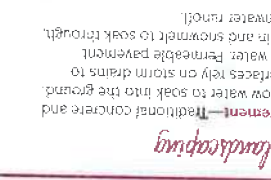
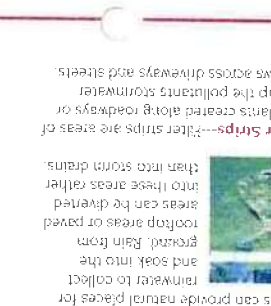
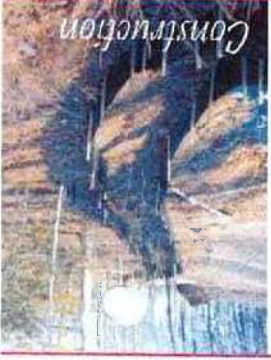

*Education is essential to cleaning people's behavior. Signs and markers near storm drains warn motorists that pollutants entering the drains will be cleaned up treated into a local waterbody.*

# Help Protect Our Waterways!

Use these guidelines for Outdoor Cleaning Activities and Wash Water Disposal

**D**id you know that disposing of pollutants into the street, gutter, storm drain or body of water is **PROHIBITED** by law and can result in stiff penalties?

## Best Management Practices

Waste wash water from Mechanics, Plumbers, Window/Power Washers, Carpet Cleaners, Car Washing and Mobile Detailing activities may contain significant quantities of motor oil, grease, chemicals, dirt, detergents, brake pad dust, litter and other materials.

Best Management Practices, or BMPs as they are known, are guides to prevent pollutants from entering the storm drains. Each of us can do our part to keep stormwater clean by using the suggested BMPs below:

## Simple solutions for both light and heavy duty jobs:

**Do...**consider dry cleaning methods first such as a mop, broom, rag or wire brush. Always keep a spill response kit on site.

**Do...**prepare the work area before power cleaning by using sand bags, rubber mats, vacuum booms, containment pads or temporary berms to keep wash water away from the gutters and storm drains.

**Do...**use vacuums or other machines to remove and collect loose debris or litter before applying water.

**Do...**obtain the property owner's permission to dispose of *small amounts* of power washing waste water on to landscaped, gravel or unpaved surfaces.

**Do...**check your local sanitary sewer agency's policies on wash water disposal regulations before disposing of wash water into the sewer. (See list on reverse side)

**Do...**be aware that if discharging to landscape areas, soapy wash water may damage landscaping. Residual wash water may remain on paved surfaces to evaporate. Sweep up solid residuals and dispose of properly. Vacuum booms are another option for capturing and collecting wash water.

**Do...**check to see if local ordinances prevent certain activities.

**Do not let...**wash or waste water from sidewalk, plaza or building cleaning go into a street or storm drain.



Report illegal storm drain disposal

Call Toll Free

1-800-506-2555

## Using Cleaning Agents

Try using biodegradable/phosphate-free products. They are easier on the environment, but don't confuse them with being toxic free. Soapy water entering the storm drain system can impact the delicate aquatic environment.



When cleaning surfaces with a **high-pressure washer** or **steam cleaner**, additional precautions should be taken to prevent the discharge of pollutants into the storm drain system. These two methods of surface cleaning can loosen additional material that can contaminate local waterways.

## Think Water Conservation

Minimize water use by using high pressure, low volume nozzles. Be sure to check all hoses for leaks. Water is a precious resource, don't let it flow freely and be sure to shut it off in between uses.

## Screening Wash Water

Conduct thorough dry cleanup before washing exterior surfaces, such as buildings and decks **with loose paint**, sidewalks or plaza areas. Keep debris from entering the storm drain after cleaning by first passing the wash water through a "20 mesh" or finer screen to catch the solid materials, then dispose of the mesh in a refuse container. Do not let the remaining wash water enter a street, gutter or storm drain.

## Drain Inlet Protection & Collection of Wash Water

- Prior to any washing, block all storm drains with an impervious barrier such as sandbags or berms, or seal the storm drain with plugs or other appropriate materials.
- Create a containment area with berms and traps or take advantage of a low spot to keep wash water contained.
- Wash vehicles and equipment on grassy or gravel areas so that the wash water can seep into the ground.
- Pump or vacuum up all wash water in the contained area.

## Concrete/Coring/Saw Cutting and Drilling Projects

Protect any down-gradient inlets by using dry activity techniques whenever possible. If water is used, minimize the amount of water used during the coring/drilling or saw cutting process. Place a barrier of sandbags and/or absorbent berms to protect the storm drain inlet or watercourse. Use a shovel or wet vacuum to remove the residue from the pavement. Do not wash residue or particulate matter into a storm drain inlet or watercourse.

## Helpful telephone numbers and links:

### Riverside County Stormwater Protection Partners

Imperial County District	(951) 955-1300
County of Riverside	(951) 955-1000
City of Banning	(951) 922-3105
City of Beaumont	(951) 769-8520
City of Calimesa	(909) 795-9801
City of Canyon Lake	(951) 244-2955
Cathedral City	(760) 770-0327
City of Coachella	(760) 398-4978
City of Corona	(951) 756-2447
City of Escondido	(760) 329-6411
City of Fontana	(951) 361-0900
City of Hemet	(951) 765-2300
City of Indio	(760) 346-2489
City of Indio Wells	(760) 391-4000
City of Lake Elsinore	(951) 674-3124
City of La Quinta	(760) 777-7000
City of Menifee	(951) 672-6777
City of Moreno Valley	(951) 413-3000
City of Murietta	(951) 304-2489
City of Norco	(951) 270-5607
City of Palm Desert	(760) 346-0611
City of Palm Springs	(760) 323-8299
City of Perris	(951) 943-6300
City of Rancho Mirage	(760) 324-4511
City of Riverside	(951) 361-0920
City of San Jacinto	(951) 654-7337
City of Temecula	(951) 694-6444
City of Wildomar	(951) 673-7751

### REPORT ILLEGAL STORM DRAIN DISPOSAL

1-800-506-2555 or e-mail us at  
[rcpdes@rcsflood.org](mailto:rcpdes@rcsflood.org)

- Riverside County Flood Control and Water Conservation District  
[www.rcflood.org](http://www.rcflood.org)
- Online resources include:
  - California Storm Water Quality Association  
[www.sqwa.org](http://www.sqwa.org)
  - State Water Resources Control Board  
[www.waterboards.ca.gov](http://www.waterboards.ca.gov)
  - Power Washers of North America  
[www.thepwna.org](http://www.thepwna.org)

## Stormwater Pollution

What you should know for...

### Outdoor Cleaning Activities and Professional Mobile Service Providers



### Storm drain pollution prevention information for:

- Car Washing / Mobile Detailers
- Window and Carpet Cleaners
- Power Washers
- Waterproofers / Street Sweepers
- Equipment cleaners or degreasers and all mobile service providers

Do you know where street flows actually go?

Storm drains are **NOT** connected to sanitary sewer systems and treatment plants!



The primary purpose of storm drains is to carry rain water away from developed areas to prevent flooding. Pollutants discharged to storm drains are transported directly into rivers, lakes and streams. Soaps, degreasers, automotive fluids, litter and a host of materials are washed off buildings, sidewalks, plazas and parking areas. Vehicles and equipment must be properly managed to prevent the pollution of local waterways.

Unintentional spills by mobile service operators can flow into storm drains and pollute our waterways. **Avoid mishaps.** Always have a **Spill Response Kit** on hand to clean up unintentional spills. Only emergency **Mechanical** repairs should be done in City streets, using drip pans for spills. **Plumbing** should be done on private property. Always store chemicals in a leak-proof container and keep covered when not in use. **Window/Power Washing** waste water shouldn't be released into the streets, but should be disposed of in a sanitary sewer, landscaped area or in the soil. Soiled **Carpet Cleaning** wash water should be filtered before being discharged into the sanitary sewer. Dispose of all filter debris properly. **Car Washing/Detailing** operators should wash cars on private property and use a regulated hose nozzle for water flow control and runoff prevention. Capture and dispose of waste water and chemicals properly. Remember, storm drains are for receiving rain water runoff only.

**REPORT ILLEGAL STORM DRAIN DISPOSAL**  
**1-800-506-2555**

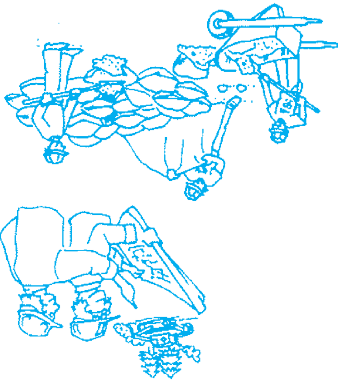

The two most common sources of stormwater pollution problems associated with construction activities are **erosion** and **sedimentation**. Failure to maintain adequate erosion and sediment controls at construction sites often results in sediment discharges into the storm drain system, creating multiple problems once it enters local waterways.

Construction vehicles and heavy equipment can also track significant amounts of mud and sediment onto adjacent streets. Additionally, wind may transport construction materials and wastes into streets storm drains, or directly into our local waterways.

## STORMWATER POLLUTION FROM CONSTRUCTION ACTIVITIES

## Resources

State Water Resources Control Board  
Division of Water Quality  
1001 I Street  
Sacramento CA 95814  
(916) 341-5455  
[www.swrcb.ca.gov/stormwtr/](http://www.swrcb.ca.gov/stormwtr/)

Colorado River Basin Regional Water  
Quality Control Board - Region 7  
73-720 Fred Waring Drive, Suite 100  
Palm Desert, CA 92260  
(760) 346-7491  
[www.swrcb.ca.gov/~rwqcb7/](http://www.swrcb.ca.gov/~rwqcb7/)

Santa Ana Regional Water  
Quality Control Board - Region 8  
3737 Main Street, Suite 500  
Riverside, CA 92501-3348  
(909) 782-4130  
[www.swrcb.ca.gov/~rwqcb8/](http://www.swrcb.ca.gov/~rwqcb8/)

San Diego Regional Water  
Quality Control Board - Region 9  
9771 Clairemont Mesa Blvd., Suite A  
San Diego, CA 92124  
(858) 467-2952  
[www.swrcb.ca.gov/~rwqcb9/](http://www.swrcb.ca.gov/~rwqcb9/)

Because preventing pollution is much easier and less costly than cleaning up "after the fact," the Cities and County of Riverside StormWater/CleanWater Protection Program informs residents and businesses on pollution prevention activities. This pamphlet describes various Best Management Practices (BMPs) that construction site operators can use to prevent stormwater pollution.

In accordance with applicable federal and state law, the Cities and County of Riverside have adopted ordinances for stormwater management and discharge control that **prohibit** the discharge of pollutants into the storm drain system or local surface water. This includes lubricants, vehicle fluids, fuel, pesticides, and construction debris.

**PLEASE NOTE:** The Federal, State and local regulations strictly prohibit the discharge of sediment and pollutants into the streets, the storm drain system or waterways. As an operator or supervisor of a construction site, you may be held financially responsible for any environmental damage caused by your subcontractors or employees.

## The Cities and County of Riverside StormWater/CleanWater Protection Program

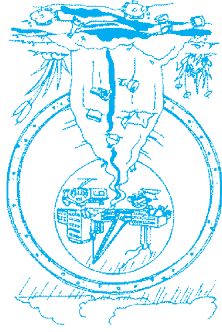

Riverside County has two drainage systems - sewers and storm drains. The storm drain system was designed to reduce flooding by carrying excess rainwater away from streets and developed areas. Since the storm drain system does not provide for water treatment, it also serves the *unintended* function of transporting pollutants directly to our local waterways.

Unlike sanitary sewers, storm drains are not connected to a wastewater treatment plant - they flow directly to our local streams, rivers and lakes.

Stormwater runoff is a part of the natural hydrologic process. However, land development and construction activities can significantly alter natural drainage processes and introduce pollutants into stormwater runoff. Polluted stormwater runoff from construction sites has been identified as a major source of water pollution in California. It jeopardizes the quality of our local waterways and can pose a serious threat to the health of our aquatic ecosystems.

## StormWater Pollution . . . What You Should Know

To report a hazardous materials spill, call:

Riverside County Hazardous Materials  
Emergency Response Team  
(909) 358-5055 8:00 a.m. - 5:00 p.m.  
(909) 358-5245 after 5:00 p.m.

In an emergency call: 911

For recycling and hazardous waste disposal, call:

(909) 358-5055

To report an illegal dumping or a clogged storm drain, call:

1-800-506-2555

To order additional brochures or to obtain information on other pollution prevention activities, please call (909) 955-1200 or visit the StormWater/CleanWater Protection Program website at:  
[www.co.riverside.ca.us/depts/flood/waterquality/npdes.asp](http://www.co.riverside.ca.us/depts/flood/waterquality/npdes.asp)



**Storm Water  
Clean Water**  
PROTECTION PROGRAM

The StormWater/CleanWater Protection Program gratefully acknowledges the Santa Clara Valley Nonpoint Pollution Control Program, Alameda Countywide CleanWater Program and the City of Los Angeles Stormwater Management Division for information provided in this brochure.

## StormWater Pollution

What you should know for...

### GENERAL CONSTRUCTION & SITE SUPERVISION

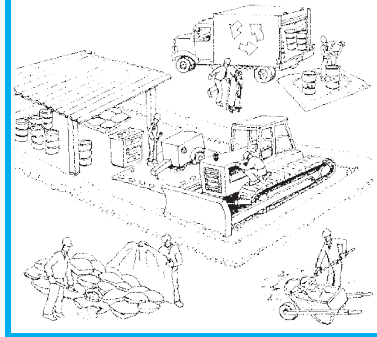

### Best Management Practices (BMPs) for:

- Developers
- General Contractors
- Home Builders
- Construction Inspectors
- Anyone in the construction business

## What Should You Do?

### Advance Planning to Prevent Pollution

- Remove existing vegetation only as needed.
- Schedule excavation, grading, and paving operations for dry weather periods, if possible.
- Designate a specific area of the construction site, well away from storm drain inlets or watercourses, for material storage and equipment maintenance.
- Develop and implement an effective combination of erosion and sediment controls for the construction site.
- Practice source reduction by ordering only the amount of materials that are needed to finish the project.
- Educate your employees and subcontractors about stormwater management requirements and their pollution prevention responsibilities.
- Control the amount of surface runoff at the construction site by impeding internally generated flows and using berms or drainage ditches to direct incoming offsite flows to go around the site. **Note:** Consult local drainage policies for more information.

## BEST MANAGEMENT PRACTICES

The following Best Management Practices (BMPs) can significantly reduce pollutant discharges from your construction site. Compliance with stormwater regulations can be as simple as minimizing stormwater contact with potential pollutants by providing covers and secondary containment for construction materials, designating areas away from storm drain systems for storing equipment and materials and implementing good housekeeping practices at the construction site.

- Protect all storm drain inlets and streams located near the construction site to prevent sediment-laden water from entering the storm drain system.
- Limit access to and from the site. Stabilize construction entrances/exits to minimize the track out of dirt and mud onto adjacent streets. Conduct frequent street sweeping.
- Protect stockpiles and construction materials from winds and rain by storing them under a roof, secured impermeable tarp or plastic sheeting.
- Avoid storing or stockpiling materials near storm drain inlets, gullies or streams.
- Phase grading operations to limit disturbed areas and duration of exposure.
- Perform major maintenance and repairs of vehicles and equipment offsite.
- Wash out concrete mixers only in designated washout areas at the construction site.
- Set-up and operate small concrete mixers on tarps or heavy plastic drop cloths.
- Keep construction sites clean by removing trash, debris, wastes, etc. on a regular basis.
- Clean-up spills immediately using dry clean-up methods (e.g., absorbent materials such as cat litter, sand or rags for liquid spills; sweeping for dry spills such as cement, mortar or fertilizer) and by removing the contaminated soil from spills on dirt areas.
- Prevent erosion by implementing any or a combination of soil stabilization practices such as mulching, surface roughening, permanent or temporary seeding.
- Maintain all vehicles and equipment in good working condition. Inspect frequently for leaks, and repair promptly.
- Practice proper waste disposal. Many construction materials and wastes, including solvents, water-based paint, vehicle fluids, broken asphalt and concrete, wood, and cleared vegetation can be recycled. Materials that cannot be recycled must be taken to an appropriate landfill or disposed of as hazardous waste.
- Cover open dumpsters with secured tarps or plastic sheeting. Never clean out a dumpster by washing it down on the construction site.
- Arrange for an adequate debris disposal schedule to insure that dumpsters do not overflow.

## GENERAL CONSTRUCTION ACTIVITIES STORMWATER PERMIT (Construction Activities General Permit)

The State Water Resources Control Board (SWRCB) adopted a new Construction Activities General Permit (WQ Order No. 99-08DWQ) on August 19, 1999, superseding the now expired SWRCB statewide General Permit (WQ Order No. 92-08DWQ). This permit is administered and enforced by the SWRCB and the local Regional Water Quality Control Boards (RWQCB). The updated Construction Activities General Permit establishes a number of new stormwater management requirements for construction site operator.

**NOTE:** Some construction activities stormwater permits are issued on a regional basis. Consult your local RWQCB to find out if your project requires coverage under any of these permits.

### Frequently Asked Questions:

#### Does my construction site require coverage under the Construction Activities General Permit?

Yes, if construction activity results in the disturbance of five or more acres of total land area or is part of a common plan of development that results in the disturbance of five or more acres.

#### How do I obtain coverage under the Construction Activities General Permit?

Obtain the permit package and submit the completed Notice of Intent (NOI) form to the

SWRCB prior to grading or disturbing soil at the construction site. For ongoing construction activity involving a change of ownership, the new owner must submit a new NOI within 30 days of the date of change of ownership. The completed NOI along with the required fee should be mailed to the SWRCB.

#### What must I do to comply with the requirements of the Construction Activities General Permit?

- Implement BMPs for non-stormwater discharges year-round.
- Prepare and implement a Stormwater Pollution Prevention Plan (SWPPP) prior to commencing construction activities.
- Keep a copy of the SWPPP at the construction site for the entire duration of the project.
- Calculate the anticipated stormwater runoff.
- Implement an effective combination of erosion and sediment control on all soil disturbed areas.
- Conduct site inspections prior to anticipated storm events, every 24-hours during extended storm events, and after actual storm event.
- Perform repair and maintenance of BMPs as soon as possible after storm events depending upon worker safety.

- Update the SWPPP as needed, to manage pollutants or reflect changes in site conditions.
- Include description of post construction BMPs at the construction site, including parties responsible for long-term maintenance.

**NOTE:** Please refer to the Construction Activities General Permit for detailed information. You may contact the SWRCB, your local RWQCB, or visit the SWRCB website at [www.swrcb.ca.gov/stormwtr/](http://www.swrcb.ca.gov/stormwtr/) to obtain a State Construction Activities Stormwater General Permit packet.

#### How long is this Construction Activities General Permit in effect?

The Permit coverage stays in effect until you submit a Notice of Termination (NOT) to the SWRCB. For the purpose of submitting a NOT, all soil disturbing activities have to be completed and one of the three following criteria has to be met:

1. Change of ownership;
2. A uniform vegetative cover with 70 percent coverage has been established; or,
3. Equivalent stabilization measures such as the use of reinforced channel liners, soil cement, fiber matrices, geotextiles, etc., have been employed.

## For Information:

For more information on the General Industrial Storm Water Permit contact:

State Water Resources Control Board (SWRCB)  
(916) 657-1146 or [www.swrcb.ca.gov/](http://www.swrcb.ca.gov/) or, at your  
Regional Water Quality Control Board (RWQCB):

Santa Ana Region (8)  
California Tower  
3737 Main Street, Ste. 500  
Riverside, CA 92501-3339  
(909) 782-4130

San Diego Region (9)  
9771 Clairemont Mesa Blvd., Ste. A  
San Diego, CA 92124  
(619) 467-2952

Colorado River Basin Region (7)  
73-720 Fred Waring Dr., Ste. 100  
Palm Desert, CA 92260  
(760) 346-7491

### SPILL RESPONSE AGENCY:

HAZ-MAT: (909) 358-5055

HAZARDOUS WASTE DISPOSAL: (909) 358-5055

RECYCLING INFORMATION: 1-800-366-SAVE

TO REPORT ILLEGAL DUMPING OR A CLOGGED

STORM DRAIN: 1-800-506-2555

To order additional brochures or to obtain information on other pollution prevention activities, call: (909) 955-1111.



Riverside County gratefully acknowledges the State Water Quality Control Board and the American Public Works Association, Storm Water Quality Task Force for the information provided in this brochure.

## DID YOU KNOW . . .

### YOUR FACILITY MAY NEED A STORM WATER PERMIT?



Many industrial facilities and manufacturing operations must obtain coverage under the Industrial Activities Storm Water General Permit

**FIND OUT  
IF YOUR FACILITY  
MUST OBTAIN A PERMIT**

## StormWater Pollution . . . What you should know

Riverside County has two drainage systems - sanitary sewers and storm drains. The storm drain system is designed to help prevent flooding by carrying excess rainwater away from streets. Since the storm drain system does not provide for water treatment, it also serves the unintended function of transporting pollutants directly to our waterways.

*Unlike sanitary sewers, storm drains are not connected to a treatment plant - they flow directly to our local streams, rivers and lakes.*

In recent years, awareness of the need to protect water quality has increased. As a result, federal, state, and local programs have been established to reduce polluted stormwater discharges to our waterways. The emphasis of these programs is to prevent stormwater pollution since it's much easier, and less costly, than cleaning up "after the fact."

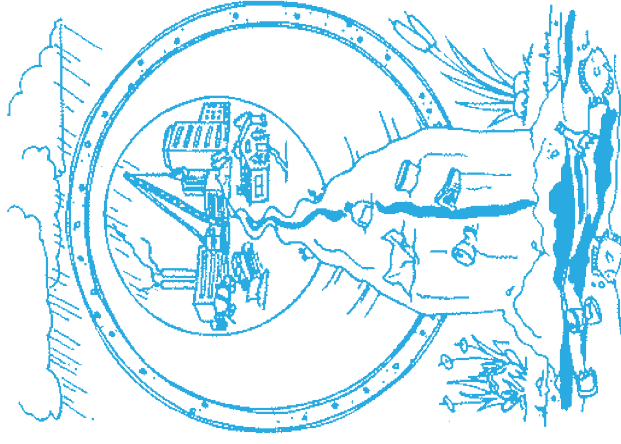

## National Pollutant Discharge Elimination System (NPDES)

In 1987, the Federal Clean Water Act was amended to establish a framework for regulating industrial stormwater discharges under the NPDES permit program. In California, NPDES permits are issued by the State Water Resources Control Board (SWRCB) and the nine (9) Regional Water Quality Control Boards (RWQCB). In general, certain industrial facilities and manufacturing operations must obtain coverage under the Industrial Activities Storm Water General Permit if the type of facilities or operations falls into one of the several categories described in this brochure.

## How Do I Know If I Need A Permit?

Following are **general descriptions** of the industry categories types that are regulated by the Industrial Activities Storm Water General Permit. Contact your local Region Water Quality Control Board to determine if your facility/operation requires coverage under the Permit.

- Facilities such as cement manufacturing; feedlots; fertilizer manufacturing; petroleum refining; phosphate manufacturing; steam electric power generation; coal mining; mineral mining and processing; ore mining and dressing; and asphalt emulsion;
- Facilities classified as lumber and wood products (except wood kitchen cabinets); pulp, paper, and paperboard mills; chemical producers (except some pharmaceutical and biological products); petroleum and coal products; leather production and products; stone, clay and glass products; primary metal industries; fabricated structural metal; ship and boat building and repairing;
- Active or inactive mining operations and oil and gas exploration, production, processing, or treatment operations;
- Hazardous waste treatment, storage, or disposal facilities;

- Landfills, land application sites and open dumps that receive or have received any industrial waste; unless there is a new overlying land use such as a golf course, park, etc., and there is no discharge associated with the landfill;
- Facilities involved in the recycling of materials, including metal scrap yards, battery reclaimers, salvage yards, and automobile junkyards;
- Steam electric power generating facilities, facilities that generate steam for electric power by combustion;
- Transportation facilities that have vehicle maintenance shops, fueling facilities, equipment cleaning operations, or airport deicing operations. This includes school bus maintenance facilities operated by a school district;
- Sewage treatment facilities;
- Facilities that have areas where material handling equipment or activities, raw materials, intermediate products, final products, waste materials, by-products, or industrial machinery are exposed to storm water.

## How do I obtain coverage under the Industrial Activities Storm Water General Permit?

Obtain a permit application package from your local Regional Water Quality Control Board listed on the back of this brochure or the State Water Resources Control Board (SWRCB). Submit a completed Notice of Intent (NOI) form, site map and the appropriate fee (\$250 or \$500) to the SWRCB. Facilities must submit an NOI thirty (30) days prior to beginning operation. Once you submit the NOI, the State Board will send you a letter acknowledging receipt of your NOI and will assign your facility a waste discharge identification number (WDID No.). You will also receive an annual fee billing. These billings should roughly coincide with the date the State Board processed your original NOI submittal.

## What are the requirements of the Industrial Activities Storm Water General Permit?

The basic requirements of the Permit are:

1. The facility must eliminate any non-stormwater discharges or obtain a separate permit for such discharges.
2. The facility must develop and implement a Storm Water Pollution Prevention Plan (SWPPP). The SWPPP must identify sources of pollutants that may be exposed to stormwater. Once the sources of pollutants have been identified, the facility operator must develop and implement Best Management Practices (BMPs) to minimize or prevent polluted runoff.  
*Guidance in preparing a SWPPP is available from a document prepared by the California Storm Water Quality Task Force called the California Storm Water Best Management Practice Handbook.*
3. The facility must develop and implement a Monitoring Program that includes conducting visual observations and collecting samples of the facility's storm water discharges associated with industrial activity. The General Permit requires that the analysis be conducted by a laboratory that is certified by the State of California.
4. The facility must submit to the Regional Board, every July 1, an annual report that includes the results of its monitoring program.

**A Non-Storm Water Discharge is...** any discharge to a storm drain system that is not composed entirely of storm water. The following non-storm water discharges are authorized by the General Permit: fire hydrant flushing; potable water sources, including potable water related to the operation, maintenance, or testing of potable water systems; drinking fountain water; atmospheric condensates including refrigeration, air conditioning, and compressor condensate; irrigation drainage; landscape watering; springs; non-contaminated ground water; foundation or footing drainage; and sea water infiltration where the sea waters are discharged back into the sea water source.

**A BMP is . . .** a technique, process, activity, or structure used to reduce the pollutant content of a storm water discharge. BMPs may include simple, non-structural methods such as good housekeeping, staff training and preventive maintenance. Additionally, BMPs may include structural modifications such as the installation of berms, canopies or treatment control (e.g. setting basins, oil/water separators, etc.)



**WARNING:** There are significant penalties for non-compliance: a minimum fine of \$5,000 for failing to obtain permit coverage, and, up to \$10,000 per day, per violation plus \$10 per gallon of discharge in excess of 1,000 gallons.



# Pollution Prevention

STORMWATER

## CONSTRUCTION

Cement wash, sediment, vehicle fluids, dust and hazardous debris from construction sites often make their way into the San Bernardino County storm drain system and do not get treated before reaching the Santa Ana River. This pollutes our drinking water and contaminates waterways, making them unsafe for people and wildlife. Follow these best management practices to prevent pollution and protect public health.



### Store Materials Safely

Keep construction materials and debris away from the street, gutter and storm drains. Cover exposed stockpiles of soil, sand or gravel and excavated material with plastic sheeting, protected from rain, wind and runoff.



### Ordering Materials & Recycling Waste

Reduce waste by ordering only the amounts of materials needed for the job. Use recycled or recyclable materials whenever possible. You can recycle broken asphalt, concrete, wood, and cleared vegetation. Non-recyclable materials should be taken to a landfill or disposed of as hazardous waste. For recycling and disposal information, call (908) 386-8401.



### Cleaning & Preventing Spills

Use a drip pan and funnel when draining or pouring fluids. Sweep up dry spills, instead of hosing. Be ready for spills by preparing and using spill containment and cleanup kits that include safety equipment and dry cleanup materials such as kitty litter or sawdust. To report serious spills, call 811.



### Preventing Erosion

Avoid excavation or grading during wet weather. Plant temporary vegetation or add hydromulch on slopes where construction is not immediately planned, and permanent vegetation once excavation and grading are complete. Construct diversion dikes to channel runoff to a detention basin and around the construction site. Channels can be lined with grass or roughened pavement to reduce runoff velocity.



### Maintaining Vehicles & Equipment

Maintain and refuel vehicles and equipment at a single location on-site, away from the street, gutter and storm drains. Perform major equipment repairs and washings off-site. Inspect vehicles and equipment frequently for leaks, and prevent leaks from stored vehicles by draining gas, hydraulic oil, transmission, brake and radiator fluids.

To report illegal dumping or for more information on stormwater pollution prevention, call:

**1 (800) CLEANUP**

[www.1800cleanup.org](http://www.1800cleanup.org)



# POLLUTION PREVENTION

## STORMWATER

### EXCAVATION AND GRADING

Sediment, cement wash, asphalt and vehicle fluids from soil excavation and grading often make their way into the San Bernardino County storm drain system and do not get treated before reaching the Santa Ana River. This pollutes our drinking water and contaminates waterways, making them unsafe for people and wildlife. Follow these best management practices to prevent pollution and protect public health.



#### Recycling Waste

Recycle broken asphalt, concrete, wood, and cleared vegetation whenever possible. Non-recyclable materials should be taken to a landfill or disposed of as hazardous waste. For recycling and disposal information, call (909) 388-9401.



#### Maintaining Vehicles & Equipment

Maintain and refuel vehicles and equipment at a single location on-site, away from the street, gutters and storm drains. Perform major equipment repairs and washings off-site. Inspect vehicles and equipment frequently for leaks. Use gravel approaches where truck traffic is heavy to reduce soil compaction and limit the tracking of sediment into the street.



#### Cleaning & Preventing Spills

Use a drip pan and funnel when draining or pouring fluids. Sweep up dry spills, instead of hosing. Be ready for spills by preparing and using spill containment and cleanup kits that include safety equipment and dry cleanup materials such as kitty litter or sawdust. Prevent leaks from stored vehicles by draining gas, hydraulic oil, transmission, brake and radiator fluids. To report serious spills, call 911.



#### Storing Materials

Keep construction materials and debris away from the street, gutter and storm drains. Cover exposed stockpiles of soil, sand or gravel and excavated material with plastic sheeting, protected from rain, wind and runoff.



#### Preventing Erosion

Avoid excavation or grading during wet weather. Plant temporary vegetation on slopes where construction is not immediately planned, and permanent vegetation once excavation and grading are complete. Construct diversion dikes to channel runoff. Channels can be lined with grass or roughened pavement to reduce runoff velocity.

To report illegal dumping or for more information on stormwater pollution prevention, call

**1 (800) CLEANUP**

[www.1800cleanup.org](http://www.1800cleanup.org)



# Pollution Prevention STORMWATER

## FRESH CONCRETE & MORTAR APPLICATION

Cement wash, sediment, vehicle fluids, dust and hazardous debris from construction sites often make their way into the San Bernardino County storm drain system and do not get treated before reaching the Santa Ana River. This pollutes our drinking water and contaminates waterways, making them unsafe for people and wildlife. Follow these best management practices to prevent pollution and protect public health.



### Storing Materials

Keep construction materials and debris away from the street, gutter and storm drains. Secure open bags of cement and cover exposed stockpiles of soil, sand or gravel and excavated material with plastic sheeting, protected from rain, wind and runoff.



### Ordering Materials & Recycling Waste

Reduce waste by ordering only the amounts of materials needed for the job. Use recycled or recyclable materials whenever possible. When breaking up paving, recycle the pieces at a crushing company. You can also recycle broken asphalt, concrete, wood, and cleared vegetation. Non-recyclable materials should be taken to a landfill or disposed of as hazardous waste. Call (800) 308-5500 for recycling and disposal information.

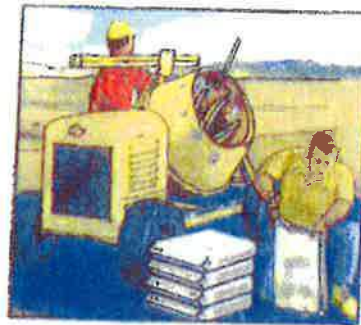

### During Construction

Schedule excavation and grading during dry weather. Prevent mortar and cement from entering the street and storm drains by placing erosion controls. Setup small mixers on tarps or drop cloths, for easy cleanup of debris. Never bury waste material. Recycle or dispose of it as hazardous waste.

### Cleaning Up

Wash concrete dust onto designated dirt areas, not down driveways or into the street or storm drains. Wash out concrete mixers and equipment in specified washout areas, where water can flow into a containment pond. Cement washwater can be recycled by pumping it back into cement mixers for reuse. Never dispose of cement washout into driveways, streets, gutters, storm drains or drainage ditches.



To report illegal dumping or for more information on stormwater pollution prevention, call:

**1 (800) CLEANUP**

[www.1800cleanup.org](http://www.1800cleanup.org)



# Pollution Prevention STORMWATER

## ROADWORK AND PAVING

Asphalt, saw-cut slurry and excavated materials from road paving, surfacing and pavement removal often make their way into the San Bernardino County storm drain system and do not get treated before reaching the Santa Ana River. This pollutes our drinking water and contaminates waterways, making them unsafe for people and wildlife. Follow these best management practices to prevent pollution and protect public health.



### Preventing Erosion

Schedule excavation and grading work during dry weather. Develop and implement erosion and sediment control plans for excavated embankments. Cover exposed stockpiles of soil, sand or gravel and excavated material with plastic sheeting, protected from rain, wind and runoff.



### During Construction

Cover catch basins and maintenance holes when applying seal coat, slurry seal or fog seal. Use check dams, ditches or berms around excavations, and avoid over applying water for dust control. Never wash excess materials from exposed aggregate or concrete into the street, gutter or a storm drain.



### Maintaining Vehicles & Equipment

Maintain and refuel vehicles and equipment at a single location on-site, away from the street, gutter and storm drains. Perform major equipment repairs and washings off-site. Inspect vehicles and equipment frequently for leaks, and prevent leaks from stored vehicles by draining gas, hydraulic oil, transmission, brake and radiator fluids.

### Asphalt & Concrete Removal

Barricade storm drain openings during saw-cutting, and recycle broken up pavement at a crushing company. For recycling information, call (909) 386-0401.



### Cleaning & Preventing Spills

Be ready for spills by preparing and using spill containment and cleanup kits that include safety equipment and dry cleanup materials such as kitty litter or sawdust. Sweep up dry spills, instead of hosing. Prevent spills from paver machines by using drip pans, or by placing absorbent materials like cloths or rags under the machines when not in use. To report serious spills, call 911.

To report illegal dumping or for more information on stormwater pollution prevention, call:

**1 (800) CLEANUP**

[www.1800cleanup.org](http://www.1800cleanup.org)



# POLLUTION STORMWATER Prevention

## PAINTING

Paints, solvents, adhesives and other toxic chemicals used in painting often make their way into the San Bernardino County storm drain system and do not get treated before reaching the Santa Ana River. This pollutes our drinking water and contaminates waterways, making them unsafe for people and wildlife. Follow these simple tips to prevent pollution and protect our health.



### Water-Based Paints

Use water-based paints whenever possible. They are less toxic than oil-based paints and easier to clean up. Look for products labeled "latex" or "cleans with water."



### Paint Removal

Sweep up paint stripping residue, chips and dust instead of hosing into the street and dispose of them safely at a household hazardous waste collection facility. Call (800) CLEANUP for the facility in your area.



### Painting Cleanup

Never clean brushes or rinse paint containers in the street, gutter or near a storm drain. Clean water-based paints in the sink. Clean oil-based paints with thinner, which can be reused by putting it in a jar to settle out the paint particles and then pouring off the clear liquid for future use. Wrap dried paint residue in newspaper and dispose of it in the trash.

### Exterior Paint Removal

When stripping or cleaning building exteriors with high-pressure water, block nearby storm drains and divert washwater onto a designated dirt area. Ask your local wastewater treatment authority if you can collect building cleaning water and discharge it to the sewer.



### Recycling Paint

Recycle leftover paint at a household hazardous waste collection facility, save it for touch ups or give it to someone who can use it, like a theatre group, school, city or community organization.

To report illegal dumping or for more information on stormwater pollution prevention, call:

**1 (800) CLEANUP**

[www.1800cleanup.org](http://www.1800cleanup.org)



# Pollution Prevention STORMWATER

## HOME & GARDEN

Yard waste and household toxics like paints and pesticides often make their way into the San Bernardino County storm drain system and do not get treated before reaching the Santa Ana River. This pollutes our drinking water and contaminates waterways, making them unsafe for people and wildlife. Follow these simple tips to prevent pollution and protect your health.



### Recycle Household Hazardous Waste

Household products like paint, pesticides, solvents and cleaners are too dangerous to dump and too toxic to trash. Take them to be recycled at a convenient household hazardous waste collection facility. Call (800) CLEANUP for the facility in your area.



### Disposing of Yard Waste

Recycle leaves, grass clippings and other yard waste, instead of blowing, sweeping or hosing into the street. Try grasscycling, leaving grass clippings on your lawn instead of using a grass catcher. The clippings act as a natural fertilizer, and because grass is mostly water, it also irrigates your lawn, conserving water.



### Use Fertilizers & Pesticides Safely

Fertilizers and pesticides are often carried into the storm drain system by sprinkler runoff. Try using organic or non-toxic alternatives. If you use chemical fertilizers or pesticides, avoid applying near curbs and driveways and never apply before a rain.



### Planting in the Yard

Produce less yard waste and save water by planting low maintenance, drought-tolerant trees and shrubs. Using drip irrigation, soaker hoses or micro-spray systems for flower beds and vegetation can also help reduce your water bill and prevent runoff.

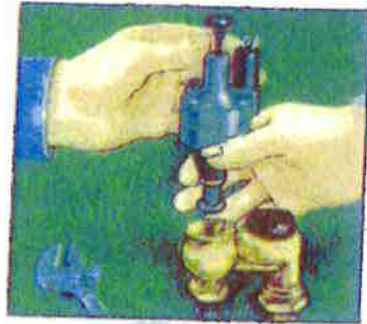

### Use Water Wisely

Cut your water costs and prevent runoff by controlling the amount of water and direction of sprinklers. The average lawn needs about an inch of water a week, including rainfall, or 10 to 20 minutes of watering. A half-inch per week is enough for fall and spring. Sprinklers should be on long enough to allow water to soak into the ground but not so long as to cause runoff.

To report illegal dumping or for more information on stormwater pollution prevention, call:

**1 (800) CLEANUP**

[www.1800cleanup.org](http://www.1800cleanup.org)



# Pollution Prevention STORMWATER

## FOOD AND RESTAURANT

Food waste, grease, cleaning fluids, mop water and trash from restaurant operations often make their way into the San Bernardino County storm drain system, and do not get treated before reaching the Santa Ana River. This pollutes our drinking water and contaminates waterways, making them unsafe for people and wildlife. Follow these best management practices to prevent pollution and protect public health.



### Recycle Oil & Grease

Oil and grease wastes can be recycled. Look in the yellow pages for rendering companies, or call (909) 386-8401 for disposal information. Don't pour oil or grease into sinks, floor drains or onto a parking lot or street. Keep grease bins covered and contained. Keep your grease interceptor maintained to prevent sewer overflows or backups and keep records of grease waste hauling.



### Dumpster Areas

Keep dumpster lids closed and the areas around them clean. Do not fill with liquid waste or hose them out. Call your trash hauler to replace any dumpsters that are damaged or leak.



### Cleaning & Maintenance

Clean equipment, floor mats, filters and garbage cans in a mop sink, wash rack or floor drain connected to the sewer through a grease trap. Don't wash them or pour wash water in a parking lot, alley, sidewalk or street. Sweep outside areas and put the debris in the garbage, instead of sweeping or hosing it into the parking lot or street.



### Managing Spills

Clean food spills in loading and trash areas by using absorbent materials and sweeping then mopping, and discharge mop water into the sewer through a grease interceptor. Have spill containment and cleanup kits available. To report serious toxic spills, call 811.



### Handling Toxic Chemicals

Dispose of all unwanted toxic materials like cleaners, solvents and detergents through a hazardous waste hauler. These items are not trash. For information on hazardous waste pickup, call (909) 386-8401. Use non-toxic cleaning products whenever possible.

To report illegal dumping or for more information on stormwater pollution prevention, call

**1 (800) CLEANUP**

[www.1800cleanup.org](http://www.1800cleanup.org)



# Prevención de Contaminación del Desagüe

## RESTAURANTES

Desechos de comida, grasa, líquidos de limpieza, agua del trapiador y basura de un restaurant acaban por llegar a los drenajes del Condado de San Bernardino y terminaando en el río de Santa Ana. Para prevenir esta contaminación y protaer la salud pública, siga estas practicas.



### Reciclando Aceite & Grasa

El aceite y la grasa se pueden reciclar. Busca en las paginas amarillas compañías de reciclaje o llama al (909) 366-8401 para información. No los tires en los lavaderos, las coladeras, el estacionamiento o en la calle. Mantén los recipientes de grasa cubiertos y guardados.



### Áreas de Basura

Mantén el bote de basura cerrado y el área del basurero limpia. No lo llenes con desechos líquidos ni utilices la manguera para lavarlo. Llena al transportador de basura para reemplazar los botes de basura que estén dañados.



### Limpiando & Mantenimiento

Limpia los tapetes de piso, los filtros y los botes de basura en el contenedor para trapeadores, lavavo, o en la coladera apropiado que llegue al drenaje. No los laves en el estacionamiento, los callejones, en la banqueto o en la calle. Barre el área de afuera y pon todo en la basura, en ves de dejarlo en la banqueto o en la calle.



### Controlando Derrames

Usa métodos secos para limpiar los derrames, barriendo y usando tierra para desechos de gato, no uses la manguera para limpiar los derrames. Mantén un kit de limpieza de derramamientos en tu negocio. Para reportar derrames llama al 311.



### Manejando Químicos Tóxicos

Deposita los desechos tóxicos como limpiadores, solventes, detergentes a un bote para tóxicos. Estos no son basura. Para más información sobre desechos peligrosos, llama al (909) 366-8401. Usa productos de limpieza que no sean tóxicos.

Para reportar actividades ilegales u obtener más información de la prevención de contaminación llámar al  
**1 (800) CLEANUP**  
[www.1800cleanup.org](http://www.1800cleanup.org)





# Prevención de Contaminación del Desagüe

## TRABAJO DE CARRETERAS & PAVIMENTO

Asfalto, mezcla y materiales de excavaciones del pavimento acaban por llegar a los drenajes del Condado de San Bernardino y terminando en el Río de Santa Ana. Esto contamina el agua que tomamos, haciéndola peligrosa para la gente y la vida salvaje. Sigue estas practicas para prevenir la contaminación y proteger la salud publica.



### Previendo Erosiones

Planea las excavaciones trabajo de jardineria durante el clima seco. Desarrolla e implementa planas de embalsamientos de control de sedimento y excavaciones. Cubre montones de tierra, grava y otros materiales con un plastico para protegerlos de la lluvia, aire y desagüe.



### Durante Construcción

Cubre los lavados y de mantenimiento a los hoyos al aplicar selladura o mezcla. Revisa las areas de excavaciones, y evita pasarte de agua para prevenir polvadura. Nunca laves los materiales llenos de concreto en la calle, drenajes o en el desagüe.



### Mantenimiento de Vehiculos & Herramientas

Hes el mantenimiento y carga de vehiculos en el mismo lugar, lejos de la calle, las alcantarillas y los drenajes. Inspecciona los vehiculos y el equipo de cualquier goteadura y evita goteaduras de autos que no se usan vistiendoles la gasolina, aceite de transmision, frenos y liquidos del radiador.

### Removiendo Asfalto & Concreto

Bloquea alrededor de los drenajes cuando estes usando las maquinas de sierra, tambien recicla todo el pavimento roto en la compania demolidora. Para más información llama al (909) 386-0401.



### Limpiando & Previendo Barridos

Mientras siempre preparado para cualquier derrame, usa siempre las herramientas de seguridad el igual que materiales como, tierra para desechos de gato o aserrin. Barre los derrames en ves de lavarlos con la manguera. Previene los darremes de las maquinas usando embudos o colocanto garras para absorver cualquier liquido. Para reportar derrames llama al 911.



Para reportar actividades ilegales u obtener más información de la prevención de contaminación llamar al:

**1 (800) CLEANUP**

[www.1800cleanup.org](http://www.1800cleanup.org)



# Prevención de Contaminación del Desagüe

## PINTURA

Pintura, solventes y otros químicos peligrosos que se usan al pintar acaban por llegar a los drenajes del Condado de San Bernardino y terminando en el Río de Santa Ana. Esto contamina el agua que tomamos, haciendola peligrosa para la gente y la vida salvaje. Sigue estas practicas para prevenir la contaminación y proteger la salud publica.



### Pinturas de Agua

Usa pinturas de agua cuando sea posible. Son menos toxicos que las pinturas de aceite y mas faciles para limpiar. Busca los productos "latex" or "cleans with water".



### Removiendo Pintura

Residuos de pintura, polvo de pintura y pinturas que contienen plomo son peligrosas. Barrelos en ves de lavarlos con la manguera y desechalos en un lugar de colección de desechos peligrosos. Llama al (888) CLEANUP para un lugar en tu area.



### Limpiaando Pintura

Nunca laves las bruchas ni los contenedores de pintura en la calle, coladeras o desagtes. Las de pintura de agua limpielas en el lavabo y las de pintura de aceite con thinner, y vuvelvas a guardar en un frasco, para un uso futuro. Envuelve los residuos de pintura en un periodico y tiralos a la basura.

### Removiendo Pintura en Exteriores

Al despintar o lavar exteriores de los edificios con agua de alta presión bloquea los drenajes cercanos y desvia el desagte. Preguata las autoridades si puedes desechaarla en las alcantallas.



### Reciclando Pintura

Recicla la pintura que sobra en un lugar de colección de materiales peligrosos, guardala para re-taques or regalala a alguien que la usa, como a un teatro, a la escuela, una oraganizacion de la ciudad o de la comunidad.

Para reportar actividades ilegales u obtener mas información de la prevención de contaminación llamar al

**1 (800) CLEANUP**

[www.1800cleanup.org](http://www.1800cleanup.org)



# EXCAVATION & GRADING OPERATIONS

Sediment, cement wash, asphalt, and motor oil from soil excavation and grading operations often make their way into the San Bernardino County storm drain system and DO

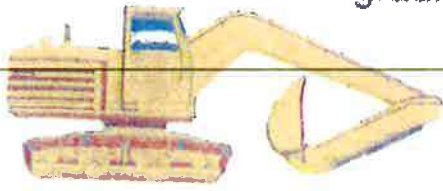

**NOT GET TREATED** before reaching the Santa Ana River. These wastes pollute our drinking water, and make our waters unhealthy and unsafe for people and wildlife.

**Follow these practices to help prevent stormwater pollution...**

## Erosion Prevention...

Reduce erosion by avoiding excavation or grading activities during wet weather, and by planting temporary vegetation on slopes where construction is not immediately planned. Plant permanent vegetation as soon as possible, once excavation and grading activities are complete. Diversion dikes can be constructed to channel runoff around the site; channels can be lined with grass or roughened pavement to reduce runoff velocity. For information on erosion control, call 799-7407.

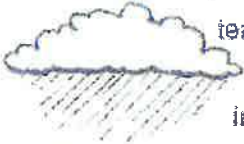

## Equipment Maintenance...

Maintain all vehicles and equipment by inspecting them frequently for leaks. Also, conduct maintenance and refueling at one location -- away from storm drains, and perform major equipment repairs and washings off site. Finally, use gravel approaches where truck traffic is frequent to reduce soil compaction and limit the tracking of sediment into the streets.



## General Business Practices...

Cover exposed piles of soil and other construction materials with plastic sheeting to prevent contact with rain water.

## Recycling...

Recycle broken asphalt, concrete, wood, and cleared vegetation whenever possible. Unrecyclable materials must be taken to an appropriate landfill or disposed of as hazardous waste. For recycling or disposal information, call 386-8401.



## Spills...

Avoid accidental spills by using a drip pan and funnel when draining or pouring fluids. Be ready for unexpected spills by preparing and using easy to find spill containment and cleanup kits.



Kits should include safety equipment and cleanup materials such as kitty litter, sawdust or cornmeal. Furthermore, prevent leaks from stored vehicles by draining gas, hydraulic oil, and transmission, brake & radiator fluid. **REMEMBER:** Never hose down dirty surfaces. To report serious spills, call 1-800-33-TOXIC.



For more information, call your city's stormwater representative



# FRESH CONCRETE & MORTAR APPLICATION

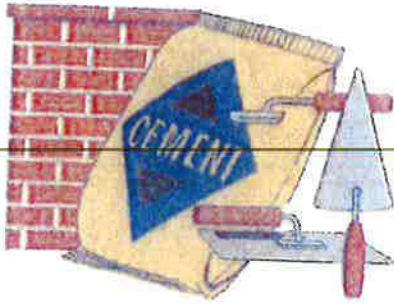

Cement, cement wash, gravel, asphalt, solvents, and motor oil from fresh concrete and mortar activities often make their way into the San Bernardino County storm drain system and **DO NOT GET TREATED** before reaching the Santa Ana River. These wastes pollute our drinking water, and make our waters unhealthy and unsafe for people and wildlife.

**Follow these practices to help prevent stormwater pollution...**

## General Business Practices...

Schedule excavation and grading work during dry weather, and in case it rains, prevent materials from contacting stormwater by storing them under cover. Also, secure open bags of cement to keep wind-blown cement powder away from streets, gutters and storm drains.



## During Construction...

Prevent mortar and cement from entering the storm drains by placing erosion controls (i.e., berms or temporary vegetation) down-slope to capture runoff. When breaking up paving, be sure to pick up all pieces and recycle them at a crushing company; small amounts of excess dry concrete, grout and mortar can be disposed of in the trash. Setup small mixers on tarps or heavy drop cloths to allow for easy cleanup of debris. **REMEMBER:** Never bury waste material -- recycle or dispose of it as hazardous waste. Call 386-8401 for recycling and disposal information.



## Handling Materials & Wastes...

Minimize wastes when ordering materials by ordering only the amounts needed to complete the job. Whenever possible, use recycled or recyclable materials. Recycle broken asphalt, concrete, wood, and cleared vegetation. Unrecyclable materials must be taken to an appropriate landfill or disposed of as hazardous waste. For recycling and disposal information, call 386-8401.



## Cleaning up...

When cleaning up after driveway or sidewalk construction, wash concrete dust onto designated dirt areas, not down the driveway or into the street or storm drain. Also, wash out concrete mixers and equipment only in specified wash-out areas, where the water flows into containment ponds. Cement washwater can be recycled by pumping it back into cement mixers for reuse. **REMEMBER:** Never dispose of cement washout into driveways, streets, gutters, storm drains or drainage ditches.



For more information, call your city's stormwater representative



# GENERAL CONSTRUCTION

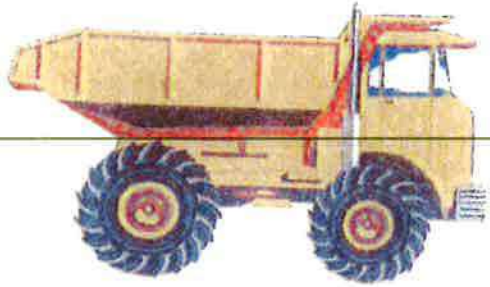

Soil, cement wash, asphalt and motor oil from construction sites often make their way into the San Bernardino County storm drain system and **DO NOT GET TREATED** before reaching the Santa Ana River. These wastes pollute our drinking water, and make our waters unhealthy and unsafe for people and wildlife.

**Follow these practices to help prevent stormwater pollution...**

## General Business Practices...

Cover exposed piles of soil and other construction materials with plastic sheeting to prevent contact with rain water.

## Erosion Prevention...

Reduce erosion by avoiding excavation or grading activities during wet weather, and by planting temporary vegetation on slopes where construction is not immediately planned.



Plant permanent vegetation as soon as possible, once excavation and grading activities are complete. Diversion dikes can be constructed to channel runoff around the site; channels can be lined with grass or roughened pavement to reduce runoff velocity. For information on erosion control, call 799-7407.

## Equipment Maintenance...

Maintain all vehicles and equipment by inspecting them frequently for leaks. Also, conduct maintenance and refueling at one location -- away from storm drains, and perform major equipment repairs and washings off site.

## Handling Materials & Waste...

Minimize wastes when ordering materials by ordering only the amounts needed to complete the job. Whenever possible, use recycled or recyclable materials. Recycle broken asphalt, concrete, wood, and cleared vegetation. Unrecyclable materials must be taken to an appropriate landfill or disposed of as hazardous waste. For recycling and disposal information, call 386-8401.

## Spills...

Avoid accidental spills by using a drip pan and funnel when draining or pouring fluids. Be ready for unexpected spills by preparing and using easy to find spill containment and cleanup kits. Kits should include safety equipment and cleanup materials such as kitty litter, sawdust or cornmeal. Furthermore, prevent leaks from stored vehicles by draining gas, hydraulic oil, and transmission, brake & radiator fluid. **REMEMBER:** Never hose down dirty surfaces; instead, sweep regularly. To report serious spills, call 1-800-33-TOXIC.



For more information, call your city's stormwater representative



# HOME & GARDEN



Yard waste and household toxics such as paints, solvents, and pesticides often make their way into the San Bernardino County storm drain system and **DO NOT GET TREATED** before reaching the Santa Ana River. These wastes pollute our drinking water and make our waters unhealthy and unsafe for people and wildlife.

**Follow these practices to help prevent stormwater pollution...**

## ***In Your Home...***

Household products such as paints, paint thinners, drain openers, motor oil, wood polishes, insecticides & herbicides, oven cleaners, and many other general cleaners frequently get dumped on the ground, or into a gutter, street or storm drain. Instead of polluting our stormwaters, take these items to a household hazardous waste collection facility. Call **1-800-OILY-CAT** for a facility in your area.



## ***Fertilizers and Pesticides...***

Fertilizers and pesticides are often carried into our storm drains by sprinkler runoff. To minimize stormwater pollution, use organic or non-toxic pesticides and fertilizers as directed, and keep them away from ditches, gutters and storm drains. Store them in a covered area, off the ground, to prevent contact with water. For additional gardening questions, call the San Bernardino Master Gardeners at 387-2182.



## ***Trimmin' the Garden...***

Decaying organic materials that enter our storm drains, such as grass, leaves, yard clippings, and pet waste, will use up oxygen in nearby streams, stressing aquatic life. Prevent stormwater pollution by not blowing, sweeping, raking or hosing yard waste into the street, gutter, or storm drain. Alternatively, leave grass clippings on your lawn after mowing, or compost your clippings and yard waste. Pet waste should not be composted, but rather disposed of in the trash to prevent the potential spread of diseases.



## ***Planting In The Yard***

Produce less yard waste and save water by planting low maintenance trees and shrubs. Also, conserve water and minimize unwanted runoff by using drip irrigation, soaker hoses, or micro-spray systems to water vegetation.



For more information, call your city's stormwater representative



# HOME REPAIR & REMODELING

Paints, solvents, adhesives, dusts, sediments, pesticides and household toxics commonly associated with home repair and remodeling activities often make their way into the San Bernardino County storm drain system and **DO NOT GET TREATED** before reaching the Santa Ana River. These wastes pollute our drinking water, and make our waters unhealthy and unsafe for people and wildlife.



**Follow these practices to help prevent stormwater pollution...**

## Household Hazardous Wastes...

Common household cleaners, paint products, and wallpaper & tile adhesives contain toxic substances. Dispose of these products properly. **REMEMBER:** Toxic wastes should never enter the storm drain system. For disposal information, call **1-800-OILY-CAT**.



## Construction...

Keep all construction debris away from the street, gutter and storm drain, and if possible, schedule grading and excavation projects for dry weather. Cover excavated material and stockpiles of asphalt, sand, etc. with plastic tarps, and prevent erosion by planting fast-growing annual and perennial grasses, which will shield and bind the soil.

## Landscape & Gardening...

Use fertilizers and pesticides as directed. Keep them away from ditches, gutters and storm drains, and store them in a covered area to prevent contact with rain water. Also, minimize runoff and conserve water by using drip irrigation, soaker hoses, or micro-spray systems. **REMEMBER:** Do not deposit leaves into the street, gutter, or storm drain.



## Painting...

**CLEANUP...** Avoid cleaning brushes or rinsing paint containers into a street, gutter, or storm drain. For water-based paints, "brush out" as much paint as possible, and rinse in the sink. For oil-based paints, "brush out" as much paint as possible, clean with thinner, and then filter and reuse thinner or solvent.



**REMOVAL...** Paint stripping residue, chips & dust from marine paints, and paints containing lead or tributyl tin are hazardous wastes. Sweep them up and call **1-800-OILY-CAT** for disposal information.

**RECYCLING...** Recycle or reuse leftover paint by using it for touch-ups, or by giving it to someone who can use it, such as a theatre group, school, city or other community organization. If you're unable to give it away, contact **1-800-OILY-CAT** for disposal information.

## Concrete & Masonry...

Store bags of cement and plaster away from gutters and storm drains, and under cover, protected from rainfall, runoff and wind. **REMEMBER:** Never dispose of cement washout or concrete dust onto driveways, streets, gutters or storm drains.

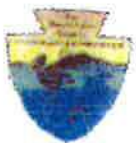

For more information, call your city's stormwater representative





# PAINTING

Paints, solvents, adhesives, and toxic chemicals from painting operations often make their way into the San Bernardino County storm drain system and **DO NOT GET TREATED** before reaching the Santa Ana River. These wastes pollute our drinking water, and make our waters unhealthy and unsafe for people and wildlife.

**Follow these practices to help prevent stormwater pollution...**

## General Business Practices...

Keep all paint products and wastes away from the street, gutter, and storm drains. Reuse paint thinner by setting used thinner aside in a closed, labeled jar to settle out paint particles, and then pouring off the clear liquid for future use. Wrap dried paint residue in newspaper and dispose of it in the trash.

## Water-Based Paints...

Purchase water-based paints whenever possible. Look for products labeled "latex" or "clean up with water."

## Recycle or Reuse Paints...

Recycle/reuse leftover paint by using it for touch-ups, or by giving it to someone who can use it, such as a theatre group, school, city or other community organization. If you're unable to give it away, contact 386-8401 for information on hazardous waste pick-up.



## Paint Cleanup...

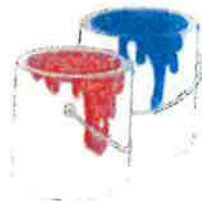

Avoid cleaning brushes and rinsing paint containers in a street, gutter, or storm drain. For water-based paints, "brush out" as much paint as possible and rinse in the sink. For oil-based paints, "brush out" as much paint as possible, clean with thinner, and then filter and reuse thinner or solvent.

## Paint Removal...

Chemical paint stripping residue, chips & dust from marine paints, and paints containing lead or tributyl tin are hazardous wastes. For disposal information, call 386-8401.

Also, when stripping or cleaning building exteriors with high-pressure water, block storm drains and divert the washwater onto a designated dirt area. Check with your local wastewater treatment authority to find out if you can collect building cleaning water and discharge it to the sewer.



For more information, call your city's stormwater representative

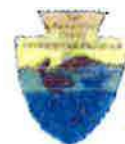



# RESTAURANTS

Food waste, grease, cleaning solvents & chemicals, mop water and trash from restaurant operations often make their way into the San Bernardino County storm drain system and **DO NOT GET TREATED** before reaching the Santa Ana River. These wastes pollute our drinking water, and make our waters unhealthy and unsafe for people and wildlife.



**Follow these practices to help prevent stormwater pollution...**

## Cleanin' It Right...

Pour mop and wash water into the mop sink or down floor drains, not into gutters, alleys, or parking lots. Wash greasy equipment only in designated wash areas properly connected to the sewer system with an appropriate oil/water separator, and avoid washing kitchen mats, garbage containers, and other items anywhere that wastewater can flow into the storm drain system.



## Water - Friendly Products...

Whenever possible, purchase water-based cleaning products. Look for products labeled "non-toxic," "non-petroleum based," "ammonia-free," "phosphate-free," "dye and perfume-free," or "readily biodegradable."

## Recycle That Waste...



Oil and grease wastes can be recycled. **REMEMBER:** Never dump them down storm drains or onto parking lots. Look in the yellow pages for rendering companies, or call **386-8401** for disposal information.

## What About Toxics...

General cleaners, floor cleaners, solvents, and detergents often contain toxic substances. Read labels carefully and store and dispose of these products properly. **REMEMBER:** Toxic wastes should never enter the storm drain system. To report toxic spills call **1-800-33-TOXIC**. For information on hazardous waste pick-up call **386-8401**.



## How 'Bout That Dumpster...

Rain can wash oil, grease, and other substances often found in dumpsters into the storm drain system. Prevent polluted runoff by covering all dumpsters and replacing leaky ones, and ensuring that the area surrounding dumpsters remains free of litter.

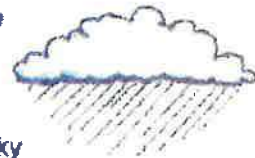

For more information, call your city's stormwater representative



# ROADWORK & PAVING

Asphalt, saw-cut slurry, and excavated materials from Road paving, surfacing and pavement removal operations often make their way into the San Bernardino County storm drain system and **DO NOT GET TREATED** before reaching the Santa Ana River. These wastes pollute our drinking water, and make our waters unhealthy and unsafe for people and wildlife.



**Follow these practices to help prevent stormwater pollution...**

## During Construction...

Cover catch basins and maintenance holes when applying seal coat, slurry seal, fog seal, etc. Use check dams, ditches or berms around excavations, and avoid over-application of water for dust control. **REMEMBER:** Never wash excess materials from exposed aggregate or concrete into a street, gutter, or storm drain; collect and recycle them.

## Asphalt & Concrete Removal...



Barricade storm drain openings during saw-cutting, and after breaking up paving, be sure to remove all chunks and pieces and recycle them at a crushing company. For recycling information, call 386-8401.

## Equipment Maintenance...

Maintain all vehicles and equipment by inspecting them frequently for leaks. Also, conduct maintenance and refueling at one location -- away from storm drains, and perform major equipment repairs and washings off site.

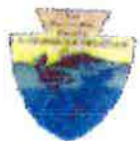

For more information, call your city's stormwater representative

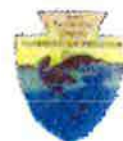

## Spills...

Be ready for unexpected spills by preparing and using spill containment and cleanup kits. Kits should include safety equipment and cleanup materials such as kitty litter, sawdust or cornmeal. Prevent drips from paver machines by catching fluids with drip pans or by placing absorbent material (cloth, rags, etc...) underneath the machines when they're not in use. To report serious spills, call 1-800-33-TOXIC.

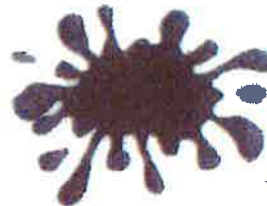

## General Business Practices...

Schedule excavation and grading work during dry weather, and develop and implement erosion and sediment control plans for excavated embankments. In case it rains, cover exposed piles of soil and other construction materials with plastic sheeting to prevent contact with rain water.



# RURAL HOMES

Pesticides, fertilizers, septic system overflows, soil, and animal manure from rural homes often make their way into the San Bernardino County storm drain system and **DO NOT GET TREATED** before reaching the Santa Ana River. These wastes pollute our drinking water, and make our waters unhealthy and unsafe for people and wildlife.



**Follow these practices to help prevent stormwater pollution...**

## Protecting Your Well...

Since old, uncapped and abandoned wells can serve as direct conduits to our groundwater, it's important to maintain these areas. Keep all livestock confinement areas away from wells, and keep septic drain fields and chemical storage areas down slope from wells. Install anti-siphoning devices between your well and water pipes to prevent backflow of pollutants and drinking water contamination. **REMEMBER:** Never dispose of anything in wells.



## Fertilizers and Pesticides...

Avoid buying and mixing more pesticide than you need, and never apply more than the recommended amount. Consider spot treatments, rather than spraying pesticides everywhere. **REMEMBER:** Don't dispose of excess chemicals by dumping them on the ground, pouring them down a well, or draining them into ditches, sewers, drains or septic systems. Call 1-800-OILY-CAT for disposal information. Finally, store chemicals in a covered area, with an impermeable lined floor to prevent contact with rainwater.



## That Rural Landscape...

Reduce soil erosion by covering parking areas with gravel, and by covering other exposed soils with vegetation. Gravel and vegetation will not only improve the appearance of your home, but will also assist in filtering out pollutants from water. For information on reducing erosion, call 799-7407.

## Autos & Other Equipment...

Repair vehicles and other equipment away from wells, ditches and drains. Avoid accidental spills by using a drip pan and funnel when draining or pouring fluids. Prevent leaks from stored vehicles by draining gas, hydraulic oil, and transmission, brake & radiator fluid. For recycling information, call 1-800-OILY-CAT



## Septic Systems

Septic systems should never be piped into a road ditch, storm sewer, stream or farm drain tile system. Also, avoid washing or flushing grease, alcohol, or strong chemicals into your septic system; these substances kill the bacteria needed to break down wastes.



For more information, call your city's stormwater representative



# Curb Inlet Filter (CIB)

PROVEN STORMWATER TREATMENT TECHNOLOGY



## Overview

The Bio Clean Curb Inlet Filter (CIB) is best known for its patented 'Shelf System'. The shelf directs water flow into the filter which is positioned directly under the manhole for easy access.

Used exclusively by numerous cities and counties for its easy maintenance and 15 minute cleaning time.

The 'Shelf System' eliminates the need for confined space entry and allows it to be serviced with a standard vacuum truck or by lifting the basket through the manhole. The 'Shelf System' makes this filter the preferred choice of maintenance crews nationwide.

This industry leading filter and shelf system are constructed of UV coated marine grade fiberglass and high grade stainless steel. Its multi-level screening and hydrocarbon media captures everything from oils & grease to sediments, to foliage and litter.

Our manufacturing capabilities allow us to make these filters and shelf systems any size. This filter is easily adaptable to any size and style of catch basin.

Includes the patented 'Shelf System'  
- Allows the Filter to Be Cleaned in 15 Minutes or Less -

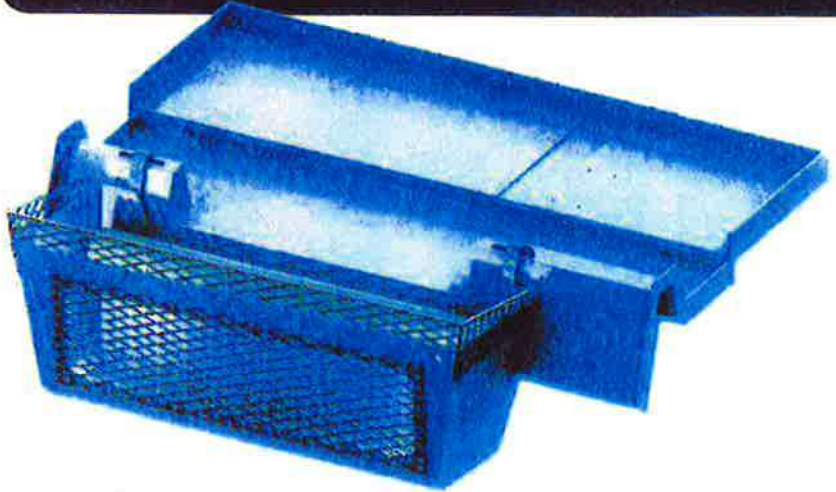

## Performance

- 93% Removal of TSS
- 84% Removal of Turbidity
- 85% Removal of Nitrates
- 79% Removal of Zinc
- 32% Removal of BOD

## Advantages

- 5 Year Warranty
- Works in Any Size Catch Basin
- No Nets or Geofabrics
- 15+ Year User Life
- Meets LEED Requirements
- Patented Shelf System
- Fiberglass Construction
- Internal Bypass

## Specifications

Model #	Treatment Flow(CFS)	Bypass Flow (CFS)
BC-CIB-3	0.85	Unlimited

### Bio Clean Filter

### Other Filters



- ✓ Cleaned Without Catch Basin Entry
- ✓ Cleaned Easily With Vac Truck
- ✗
- ✗

# Curb Inlet Filter (CIB)

PROVEN STORMWATER TREATMENT TECHNOLOGY

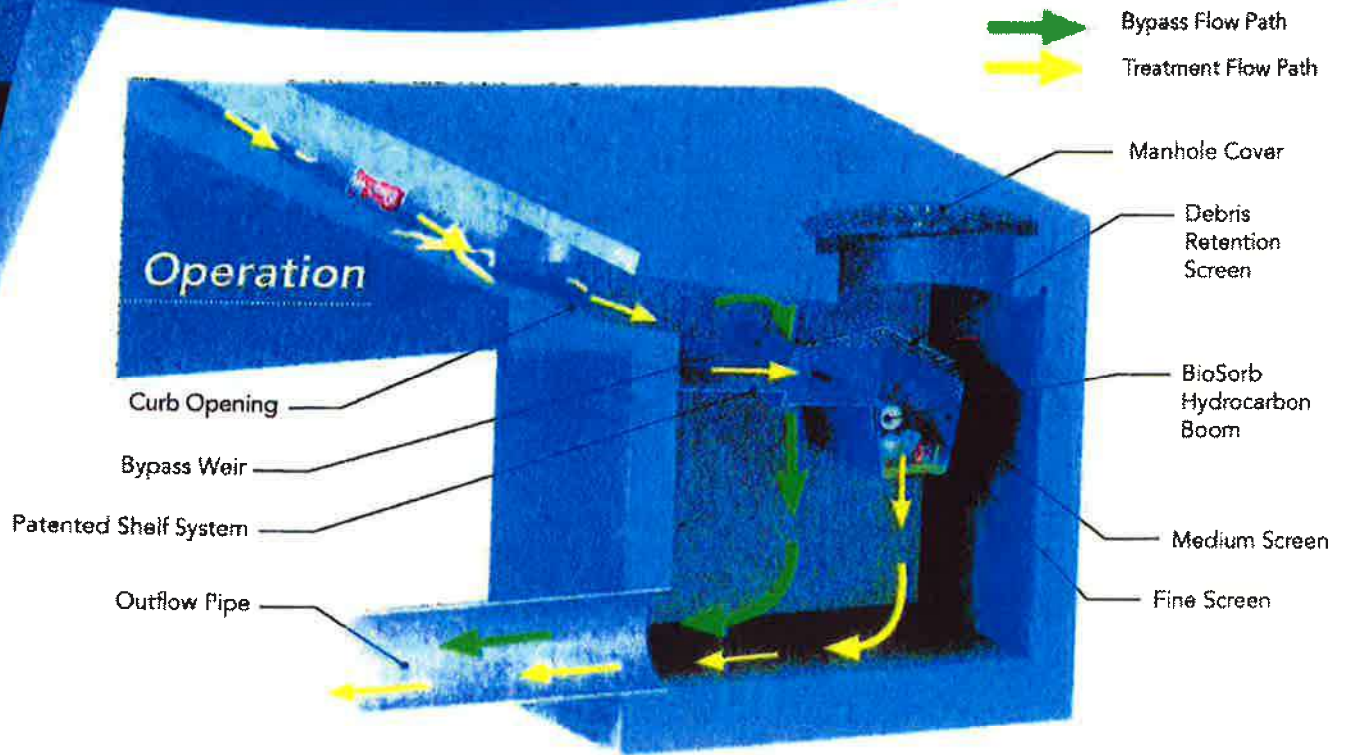

## Installation & Maintenance

Site	Company	Service Time (hours)	Total Scores (out of 25)
15	Hydrocompliance	1.75	9
17	KriStar	1.0	15
18	AbTech	0.5	18
19	Bio Clean	0.25	22

Hawaii Report Maintenance Score

## Application

- Parking Lots
- Roadways



Superior Design Maximizes Debris Capture & Retention



Easy Maintenance Access

## Approvals



City and County of Honolulu



County of San Diego

2972 San Luis Rey Rd  
Oceanside, CA 92058  
p 760.433.7640 f 760.433.3176  
[www.BioCleanEnvironmental.com](http://www.BioCleanEnvironmental.com)

**BIO CLEAN**

# Grate Inlet Filter (GISB)

PROVEN STORMWATER TREATMENT TECHNOLOGY



## Advantages

- 5 Year Warranty
- Custom Sizes Available
- Fits in Shallow Catch Basins
- No Nets or Geofabrics
- 15+ User Life
- No Replacement Costs as Found with Fabric Filters
- Meets LEED Requirements

## Performance

- 74%-86% Removal of TSS
- 54% Removal of Oils & Grease
- 57%-71% Removal of Phosphorus
- 56%-60% Removal of Nitrogen

## Specifications

Model #	Treatment Flow (CFS)	Bypass Flow (CFS)
BC-GISB-12-12-12	0.5	0.5
BC-GISB-18-18-18	0.8	0.8
BC-GISB-24-24-24	3.7	4.4
BC-GISB-36-36-24	5.8	13.4
BC-GISB-48-48-18	6.6	13.3



## Operation

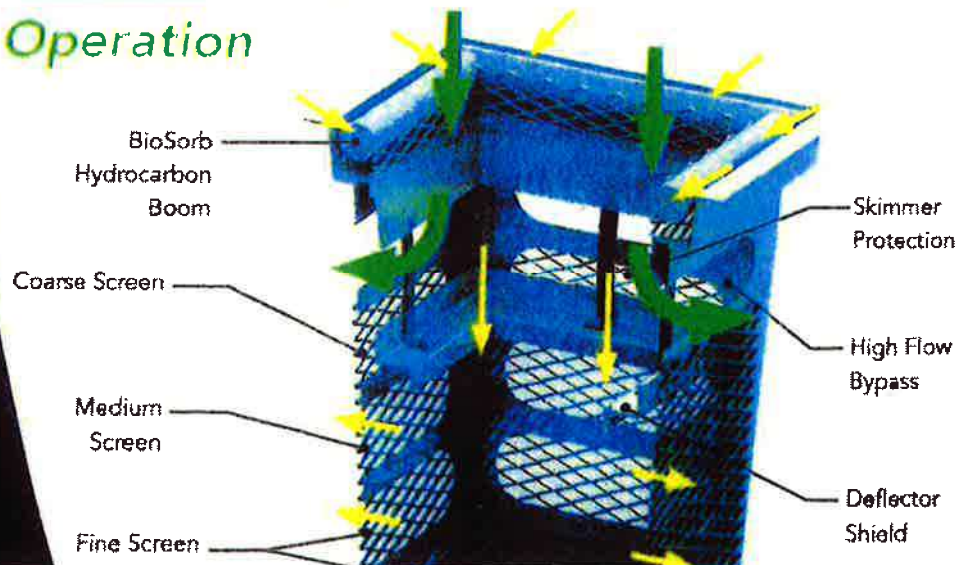

## Overview

The Bio Clean Grate Inlet Filter (GISB) for catch basins has been keeping property owners in compliance since 1994. Preferred by public agencies and backed with a 5 year unlimited warranty, this easy to install filter has been chosen because of its durability and easy maintenance.

Constructed of UV coated marine grade fiberglass and high grade stainless steel, it is built to last longer than any other filter brand. The multi-stage filtration provides three different sieve size filtration screens to optimize filtration and water flow. The filter is equipped with a hydrocarbon media boom and deflector shield protected bypass to eliminate scouring.

The filter is designed for grated inlets of any size and depth. Each filter can be custom built to meet specific project needs. Screen size and media type can be modified to remove specific pollutants.

# Grate Inlet Filter (GISB)

PROVEN STORMWATER TREATMENT TECHNOLOGY

## Media Filter

The Bio Clean Grate Inlet Media Filter (GISB-MF) is an advanced level filtration device designed with a multi-layered media filter for increased removal efficiencies.

### Performance

- 85% Removal of Fine TSS
- 69% Removal of Dissolved Phosphorus
- 95% Removal of Copper
- 87% Removal of Lead
- 95% Removal of Zinc
- 90% to 95% Removal of Oils & Grease
- 68% Removal of Fecal Coliform (bacteria)

### Specifications

Model #	Media Treatment Flow (CFS)	Screen Treatment Flow (CFS)	Bypass Flow (CFS)
8C-GISB-MF-12-12-12	0.007	0.2	0.5
8C-GISB-MF-18-18-18	0.07	0.5	0.8
8C-GISB-MF-24-24-24	0.04	0.9	4.4
8C-GISB-MF-36-36-24	0.17	1.8	13.4
5B-MF-48-48-18	0.35	2.6	13.3

### Operation



### Application

- Parking Lots
- Roadways
- Bioswale Bypass Structures

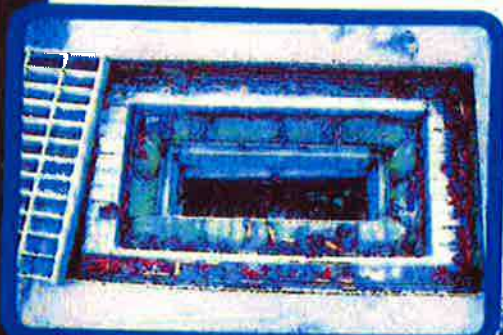

Enhanced with Media to Meet Removal Requirements



Perfect for Retrofit Applications

### Installation & Maintenance

See our website for installation &

### Approvals



County of Orange

SAN FRANCISCO



Meets Full Capture Requirements

2972 San Luis Rey Rd  
Oceanside, CA 92058  
p 760.433.7640 f 760.433.3176  
[www.BioCleanEnvironmental.com](http://www.BioCleanEnvironmental.com)



# **Attachment D**

## **Infiltration Report & Worksheet H**



August 19, 2021

Oakmont Industrial Group  
3520 Piedmont Road, Suite 100  
Atlanta, Georgia 30305



Attention: Mr. John C. Atwell  
Senior Vice President

Project No.: **21G190-2**

Subject: **Results of Infiltration Testing**  
Proposed Warehouse  
SWC Tippecanoe Avenue and 9<sup>th</sup> Street  
San Bernardino, California

Reference: Geotechnical Investigation, Proposed Warehouse, SWC Tippecanoe Avenue and 9<sup>th</sup> Street, San Bernardino, California, prepared for Oakmont Industrial Group, by Southern California Geotechnical, Inc. (SCG), SCG Project No. 21G190-1.

Mr. Atwell

In accordance with your request, we have conducted infiltration testing at the subject site. We are pleased to present this report summarizing the results of the infiltration testing and our design recommendations.

### **Scope of Services**

The scope of the infiltration testing was in general accordance with our Proposal No. 20P451R, dated April 8, 2021, and consisted of surface reconnaissance, subsurface exploration, field testing, laboratory testing, and engineering analysis to determine the infiltration rate of the on-site soils. The infiltration testing was performed in accordance with the ASTM test method D-3385-03, Standard Test Method for Infiltration Rate of Soils in Field Using Double-Ring Infiltrometer.

### **Site and Project Description**

The subject site is located at the southwest corner of Tippecanoe Avenue and 9<sup>th</sup> Street in San Bernardino, California. The site is bounded to the north by 9<sup>th</sup> Street, to the west by an existing commercial/industrial building, to the south by an existing commercial/industrial building, and to the east by Tippecanoe Avenue. The general location of the site is illustrated on the Site Location Map, enclosed as Plate 1 in Appendix A of this report.

The subject site consists of an irregular-shaped parcel, 14.3± acres in size. Based on visiting the site and aerial photographs obtained from Google Earth, the site is currently vacant and undeveloped. A concrete pad remaining from the demolition of a single-family residence remains at the ground surface in the southeastern corner of the site. Along the southeastern boundary of the site, a group of medium to large-sized trees is also present. The ground surface cover in this area consists of exposed soil with sparse native grass and weed growth.

Detailed topographic information was not available at the time of this report. However, based on topographic information obtained from Google Earth, the site slopes gently downward to the west with an average gradient of about 1± percent. There is approximately 8± feet of elevation differential across the site.

### **Proposed Development**

SCG was provided a site plan for the proposed development (Scheme 2). Based on the site plan prepared by HPA Architecture, the site will be developed with one warehouse building, approximately 287,270± ft<sup>2</sup> in size, located in the central-western area of the site. The building will be constructed with 39 dock-high doors along the eastern building wall. The building will be surrounded by asphaltic concrete pavements in the parking and drive lane areas, Portland cement concrete pavements in the loading dock areas. We expect the new development will also include areas of concrete flatwork and landscape planters.

The proposed development will include on-site stormwater infiltration. Based on our conversations with the project civil engineer and the proposed site plan, infiltration systems will consist of one (1) below-grade chamber. The infiltration chamber systems will be located in the southern area of the site. The bottom of the chamber is expected to be at 10± feet below the existing site grades.

### **Concurrent Study**

SCG concurrently conducted a geotechnical investigation at the subject site. As part of this study, five (5) borings advanced to depths of 20 to 50± feet below existing site grades. In addition to the borings, four (4) Cone Penetration Test (CPT) were advanced to depths of 50± feet. Artificial fill soils were encountered at the ground surface at all of the boring locations, extending to depths of 2½ to 5½± feet below existing site grades. The fill soils consist of medium dense to dense silty fine sands with variable medium to coarse sands and gravel content. Additional soils classified as possible fill were encountered beneath the artificial fill soils at Boring No. B-4, extending to a depth of 4½± feet below existing site grades. The artificial fill soils are similar to the underlying alluvium, but possessed a slightly disturbed appearance, resulting in their classification as possible fill. Native alluvial soils were encountered beneath the artificial fill and possible fill soils at all boring locations, extending to at least the maximum depth explored of 50± feet below existing site grades. The near-surface alluvium, extending to depth of 12 to 20± feet generally consisted of loose to medium dense silty fine to coarse sands, gravelly fine to coarse sands. At depths, the alluvium generally consists of dense to very dense silty fine to coarse sands and gravelly fine to coarse sands.

### **Groundwater**

Free water was not encountered during the drilling of any of the borings. Based on the moisture content of the recovered soil samples, groundwater levels exist at depths greater than the maximum explored depth of 50± feet below existing site grades.

Research of historic high groundwater levels was performed as a part of the site-specific liquefaction evaluation. USGS Bulletin 1898 (Matti and Carson, 1991) indicates that the minimum historic depth to groundwater at the site is 8± feet below existing site grades.

Research of historic high groundwater levels was performed as a part of the site-specific liquefaction evaluation. USGS Bulletin 1898 (Matti and Carson, 1991) indicates that the minimum historic depth to groundwater at the site is 8± feet below existing site grades. As part of our research, we reviewed readily available groundwater data in order to determine regional groundwater depths. The primary reference used to determine the groundwater depths in the subject site area is the California State Water Resources Control Board website, GeoTracker, <https://geotracker.waterboards.ca.gov>. The nearest monitoring well is located approximately 1± mile northeast of the site. Water level readings within this monitoring well indicates a high groundwater level of 52± feet below the ground surface in May 2010.

## **Subsurface Exploration**

### Scope of Exploration

The subsurface exploration conducted for this project consisted of two (2) backhoe-excavated infiltration trenches to a depth of 10± feet below existing site grades. The trenches were logged during excavation by a member of our staff. The approximate locations of the infiltration trenches (identified as I-1 through I-2) are included in this report as Plate 2.

### Geotechnical Conditions

Fill soils were encountered at the ground surface at each trench location, extending to a depth of 5 to 5½± feet below existing site grades. The fill soil consists of loose to medium dense silty sands and fine to medium sands. Native alluvium was encountered below the fill soils at each trench location, extending to at least the maximum explored depth of 10± feet below existing site grades. The alluvium consists of loose to medium dense silty sands, gravelly sands and sandy gravels. Occasional cobble content was encountered at both trench locations. The Trench Logs, which illustrate the conditions encountered at each of the infiltration trenches, are presented in this report.

## **Infiltration Testing**

We understand that the results of the testing will be used to prepare a preliminary design for the storm water infiltration systems that will be used at the subject site. As previously mentioned, the infiltration testing was performed in general accordance with ASTM Test Method D-3385-03, Standard Test Method for Infiltration Rate of Soils in Field Using Double Ring Infiltrometer.

Two stainless steel infiltration rings were used for the infiltration testing. The outer infiltration ring is 2 feet in diameter and 20 inches in height. The inner infiltration ring is 1 foot in diameter and 20 inches in height. At each test location, a trench was excavated to the proposed depth of the infiltration system and the outer ring was driven 3± inches into the soil at the base of each trench. The inner ring was centered inside the outer ring and subsequently driven 3± inches into the soil at the base of the trench. The rings were driven into the soil using a ten-pound sledge hammer. The soil surrounding the wall of the infiltration rings was only slightly disturbed during the driving process.

## Infiltration Testing Procedure

Infiltration testing was performed at both of the infiltration trench locations. The infiltration testing consisted of filling the inner ring and the annular space (the space between the inner and outer rings) with water, approximately 3 to 4± inches above the soil. To prevent the flow of water from one ring to the other, the water level in both the inner ring and the annular space between the rings was maintained using constant-head float valves. The volume of water that was added to maintain a constant head in the inner ring and the annular space during each time interval was determined and recorded. A cap was placed over the rings to minimize the evaporation of water during the tests.

The schedule for readings was determined based on the observed soil type at the base of each backhoe-excavated trench. Based on the existing soils at the trench locations, the volumetric measurements were made at 3-minute increments at both testing locations. The water volume measurements are presented on the spreadsheets enclosed with this report. The infiltration rates for each of the timed intervals are also tabulated on these spreadsheets.

The infiltration rates for the infiltration tests are calculated in centimeters per hour and then converted to inches per hour. The rates are summarized below:

<b><u>Infiltration Test No.</u></b>	<b><u>Depth (feet)</u></b>	<b><u>Soil Description</u></b>	<b><u>Infiltration Rate (inches/hour)</u></b>
I-1	10	Red Brown fine to coarse Sandy Gravel, occasional Cobbles, trace Silt	19.4
I-2	10	Brown to Red Brown Gravelly fine to coarse Sand, occasional Cobbles	20.0

## **Laboratory Testing**

### Moisture Content

The moisture contents for selected soil samples within the trenches were determined in accordance with ASTM D-2216 and are expressed as a percentage of the dry weight. These test results are presented on the Trench Logs in Plates B-1 and B-2 of this report.

### Grain Size Analysis

The grain size distribution of selected soils collected from the base of each infiltration test trench has been determined using a range of wire mesh screens. These tests were performed in general accordance with ASTM D-422 and/or ASTM D-1140. The weight of the portion of the sample retained on each screen is recorded and the percentage finer or coarser of the total weight is calculated. The results of the grainsize analysis are presented on Plates C-1 through C-2 of this report.

## **Design Recommendations**

Two (2) infiltration tests were performed at the subject site. As noted above, the infiltration rates at these locations vary from 19.4 to 20.0 inches per hour. Based on the results of Infiltration Test Nos. I-1 and I-2, we recommend an infiltration rate of 20.0 inches per hour.

The design of the storm water infiltration system should be performed by the project civil engineer, in accordance with the City of San Bernardino and/or County of San Bernardino guidelines. It is recommended that the system be constructed so as to facilitate removal of silt and clay, or other deleterious materials from any water that may enter the systems. The presence of such materials would decrease the effective infiltration rates. **It is recommended that the project civil engineer apply an appropriate factor of safety. The infiltration rates recommended above is based on the assumption that only clean water will be introduced to the subsurface profile. Any fines, debris, or organic materials could significantly impact the infiltration rate.** It should be noted that the recommended infiltration rates are based on infiltration testing at two (2) discrete locations and that the overall infiltration rates of the proposed infiltration systems could vary considerably.

## **Infiltration Rate Considerations**

The infiltration rates presented herein was determined in accordance with the San Bernardino County guidelines and are considered valid only for the time and place of the actual test. Varying subsurface conditions will exist in other areas of the site, which could alter the recommended infiltration rates presented above. The infiltration rates will decline over time between maintenance cycles as silt or clay particles accumulate on the BMP surface. The infiltration rate is highly dependent upon a number of factors, including density, silt and clay content, grainsize distribution throughout the range of particle sizes, and particle shape. Small changes in these factors can cause large changes in the infiltration rates.

Infiltration rates are based on unsaturated flow. As water is introduced into soils by infiltration, the soils become saturated and the wetting front advances from the unsaturated zone to the saturated zone. Once the soils become saturated, infiltration rates become zero, and water can only move through soils by hydraulic conductivity at a rate determined by pressure head and soil permeability. Changes in soil moisture content will affect the infiltration rate. Infiltration rates should be expected to decrease until the soils become saturated. Soil permeability values will then govern groundwater movement. Permeability values may be on the order of 10 to 20 times less than infiltration rates. The system designer should incorporate adequate factors of safety and allow for overflow design into appropriate traditional storm drain systems, which would transport storm water off-site.

## **Construction Considerations**

The infiltration rates presented in this report are specific to the tested locations and tested depths. Infiltration rates can be significantly reduced if the soils are exposed to excessive disturbance or compaction during construction. Compaction of the soils at the bottom of the infiltration system can significantly reduce the infiltration ability of the basins. Therefore, the subgrade soils within proposed infiltration system areas should not be over-excavated, undercut or compacted in any significant manner. **It is recommended that a note to this effect be added to the project plans and/or specifications.**

We recommend that a representative from the geotechnical engineer be on-site during the construction of the proposed infiltration systems to identify the soil classification at the base of each system. It should be confirmed that the soils at the base of the proposed infiltration systems correspond with those presented in this report to ensure that the performance of the systems will be consistent with the rates reported herein.

We recommend that scrapers and other rubber-tired heavy equipment not be operated on the basin bottom, or at levels lower than 2 feet above the bottom of the system, particularly within basins. As such, the bottom 24 inches of the infiltration systems should be excavated with non-rubber-tired equipment, such as excavators.

### **Basin Maintenance**

The proposed project may include infiltration basins. Water flowing into these basins will carry some level of sediment. Wind-blown sediments and erosion of the basin side walls will also contribute to sediment deposition at the bottom of the basin. This layer has the potential to significantly reduce the infiltration rate of the basin subgrade soils. Therefore, a formal basin maintenance program should be established to ensure that these silt and clay deposits are removed from the basin on a regular basis. Appropriate vegetation on the basin sidewalls and bottom may reduce erosion and sediment deposition.

Basin maintenance should also include measures to prevent animal burrows, and to repair any burrows or damage caused by such. Animal burrows in the basin sidewalls can significantly increase the risk of erosion and piping failures.

### **Location of Infiltration Systems**

The use of on-site storm water infiltration systems carries a risk of creating adverse geotechnical conditions. Increasing the moisture content of the soil can cause the soil to lose internal shear strength and increase its compressibility, resulting in a change in the designed engineering properties. Overlying structures and pavements in the infiltration area could potentially be damaged due to saturation of the subgrade soils. **The proposed infiltration systems for this site should be located at least 25 feet away from any structures, including retaining walls.** Even with this provision of locating the infiltration system at least 25 feet from the building(s), it is possible that infiltrating water into the subsurface soils could have an adverse effect on the proposed or existing structures. It should also be noted that utility trenches which happen to collect storm water can also serve as conduits to transmit storm water toward the structure, depending on the slope of the utility trench. Therefore, consideration should also be given to the proposed locations of underground utilities which may pass near the proposed infiltration system.

The infiltration system designer should also give special consideration to the effect that the proposed infiltration systems may have on nearby subterranean structures, open excavations, or descending slopes. In particular, infiltration systems should not be located near the crest of descending slopes, particularly where the slopes are comprised of granular soils. Such systems will require specialized design and analysis to evaluate the potential for slope instability, piping failures and other phenomena that typically apply to earthen dam design. This type of analysis is beyond the scope of this infiltration test report, but these factors should be considered by the infiltration system designer when locating the infiltration systems.

## **General Comments**

This report has been prepared as an instrument of service for use by the client in order to aid in the evaluation of this property and to assist the architects and engineers in the design and preparation of the project plans and specifications. This report may be provided to the contractor(s) and other design consultants to disclose information relative to the project. However, this report is not intended to be utilized as a specification in and of itself, without appropriate interpretation by the project architect, structural engineer, and/or civil engineer. The design of the infiltration system is the responsibility of the civil engineer. The role of the geotechnical engineer is limited to determination of infiltration rate only. By using the design infiltration rates contained herein, the civil engineer agrees to indemnify, defend, and hold harmless the geotechnical engineer for all aspects of the design and performance of the infiltration system. The reproduction and distribution of this report must be authorized by the client and Southern California Geotechnical, Inc. Furthermore, any reliance on this report by an unauthorized third party is at such party's sole risk, and we accept no responsibility for damage or loss which may occur. The analysis of this site was based on a subsurface profile interpolated from limited discrete soil samples. While the materials encountered in the project area are considered to be representative of the total area, some variations should be expected between trench locations and testing depths. If the conditions encountered during construction vary significantly from those detailed herein, we should be contacted immediately to determine if the conditions alter the recommendations contained herein.

This report has been based on assumed or provided characteristics of the proposed development. It is recommended that the owner, client, architect, structural engineer, and civil engineer carefully review these assumptions to ensure that they are consistent with the characteristics of the proposed development. If discrepancies exist, they should be brought to our attention to verify that they do not affect the conclusions and recommendations contained herein. We also recommend that the project plans and specifications be submitted to our office for review to verify that our recommendations have been correctly interpreted. The analysis, conclusions, and recommendations contained within this report have been promulgated in accordance with generally accepted professional geotechnical engineering practice. No other warranty is implied.

**Closure**

We sincerely appreciate the opportunity to be of service on this project. We look forward to providing additional consulting services during the course of the project. If we may be of further assistance in any manner, please contact our office.

Respectfully Submitted,

**SOUTHERN CALIFORNIA GEOTECHNICAL, INC.**



Jose Zuniga  
Staff Engineer



Robert G. Trazo, GE 2655  
Principal Engineer



Distribution: (1) Addressee

Enclosures: Plate 1 - Site Location Map  
Plate 2 - Infiltration Test Location Plan  
Trench Logs & Trench Log Legend (4 pages)  
Infiltration Test Results Spreadsheets (4 pages)  
Grain Size Distribution Graphs (2 pages)



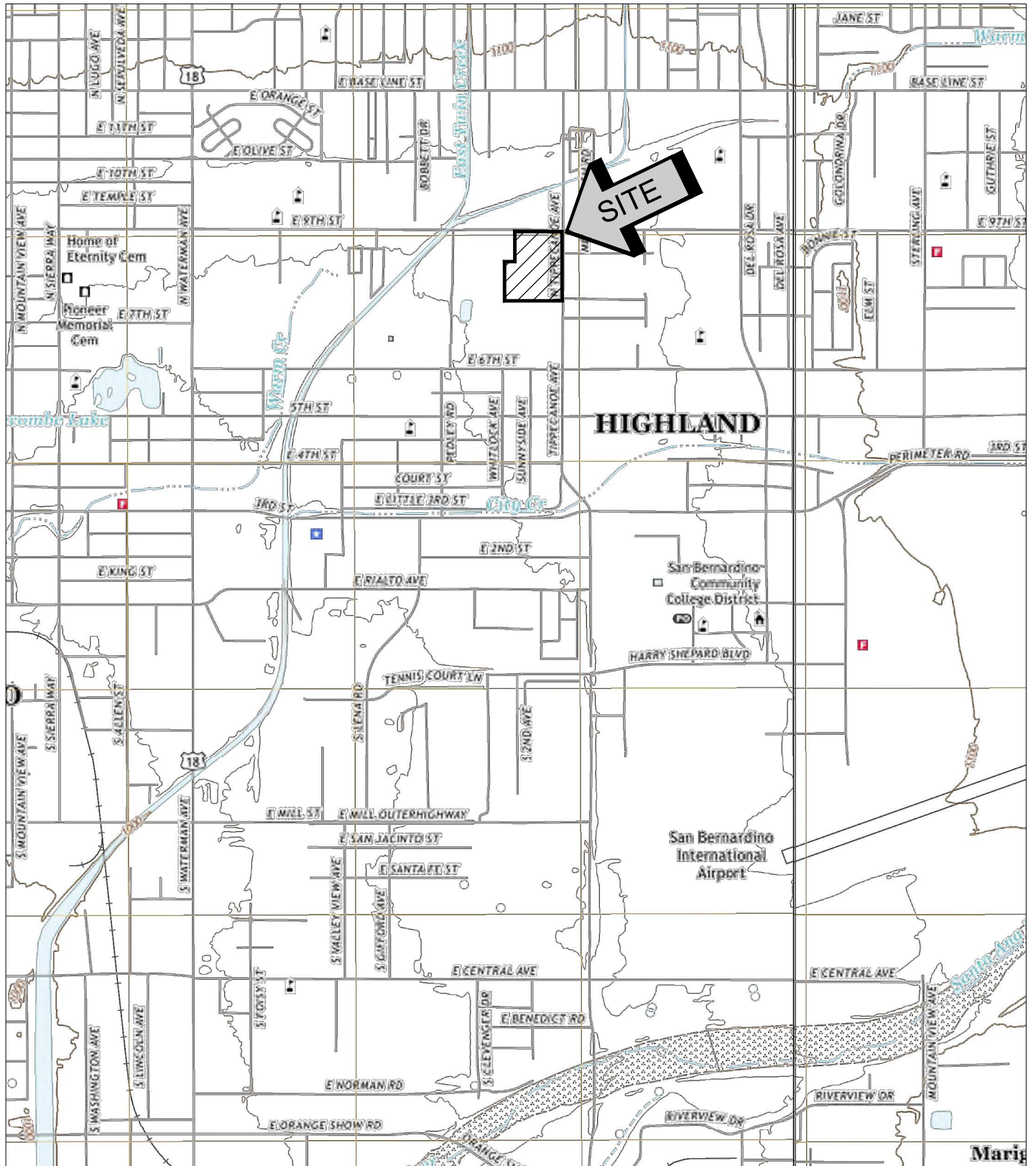

SOURCE: USGS TOPOGRAPHIC MAPS OF THE SAN BERNARDINO SOUTH AND REDLANDS QUADRANGLES, SAN BERNARDINO COUNTY, CALIFORNIA, 2018.



<b>SITE LOCATION MAP</b>	
<b>PROPOSED WAREHOUSE</b>	
<b>SAN BERNARDINO, CALIFORNIA</b>	
SCALE: 1" = 2000'	 <b>SOUTHERN CALIFORNIA GEOTECHNICAL</b>
DRAWN: JZ	
CHKD: RGT	
SCG PROJECT 21G190-2	
<b>PLATE 1</b>	

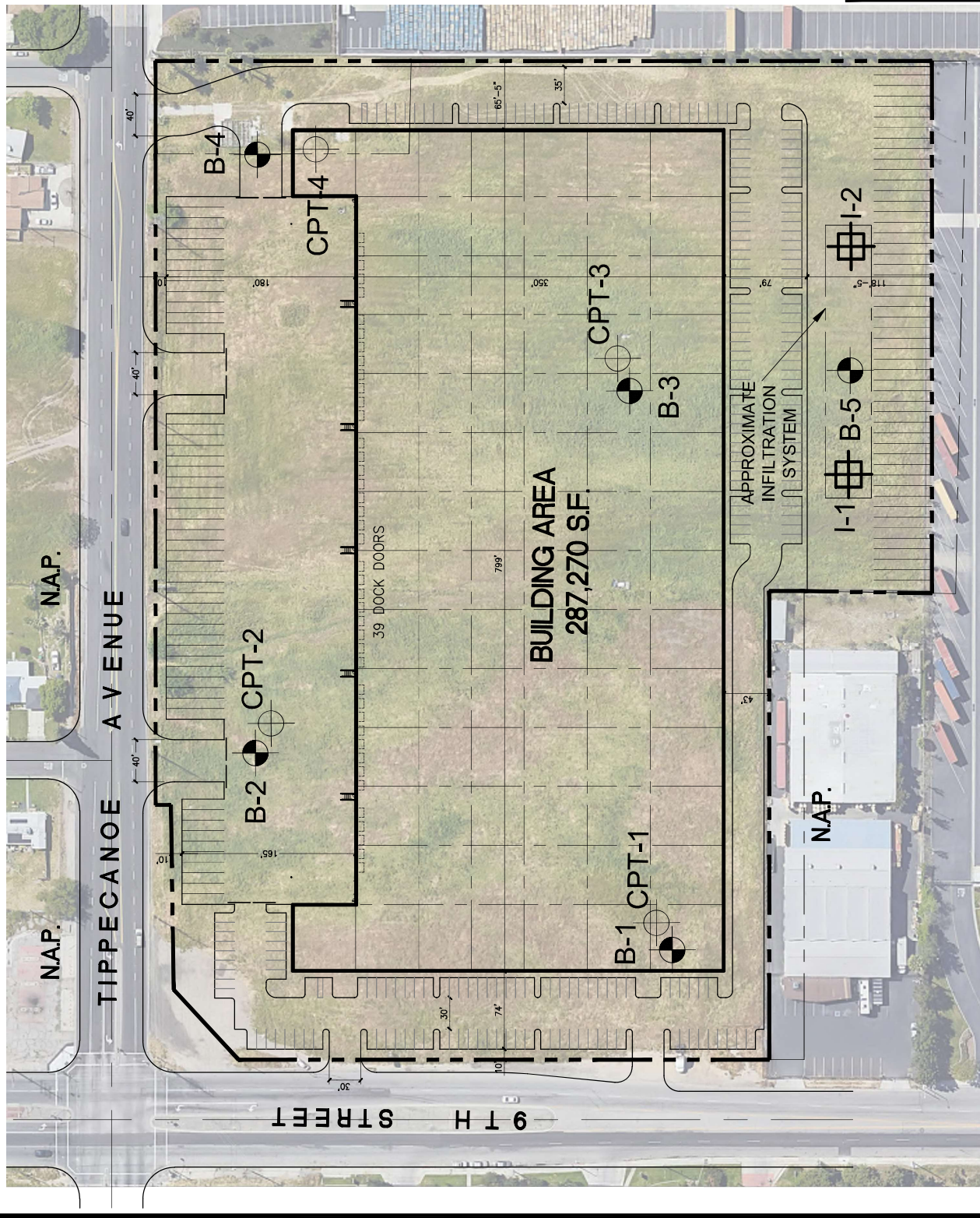

**GEOTECHNICAL LEGEND**

- # APPROXIMATE INFILTRATION TEST LOCATION
- APPROXIMATE BORING LOCATION (SCG PROJECT NO. 21G190-1)
- ⊙ APPROXIMATE CPT LOCATION (SCG PROJECT NO. 21G190-1)

NOTE: SITE PLAN PROVIDED BY HPA.  
AERIAL PHOTOGRAPH OBTAINED FROM GOOGLE EARTH.

**INFILTRATION TEST LOCATION PLAN**

PROPOSED WAREHOUSE

SAN BERNARDINO, CALIFORNIA

SCALE: 1" = 90'

DRAWN: JAZ

CHKD: RET







SCG PROJECT 21G190-2

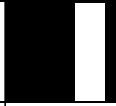

SOUTHERN CALIFORNIA GEOTECHNICAL

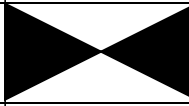
PLATE 2

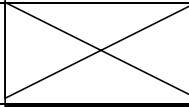
# TRENCH LOG LEGEND

SAMPLE TYPE	GRAPHICAL SYMBOL	SAMPLE DESCRIPTION
<b>AUGER</b>		SAMPLE COLLECTED FROM AUGER CUTTINGS, NO FIELD MEASUREMENT OF SOIL STRENGTH. (DISTURBED)
<b>CORE</b>		ROCK CORE SAMPLE: TYPICALLY TAKEN WITH A DIAMOND-TIPPED CORE BARREL. TYPICALLY USED ONLY IN HIGHLY CONSOLIDATED BEDROCK.
<b>GRAB</b>		SOIL SAMPLE TAKEN WITH NO SPECIALIZED EQUIPMENT, SUCH AS FROM A STOCKPILE OR THE GROUND SURFACE. (DISTURBED)
<b>CS</b>		CALIFORNIA SAMPLER: 2-1/2 INCH I.D. SPLIT BARREL SAMPLER, LINED WITH 1-INCH HIGH BRASS RINGS. DRIVEN WITH SPT HAMMER. (RELATIVELY UNDISTURBED)
<b>NSR</b>		NO RECOVERY: THE SAMPLING ATTEMPT DID NOT RESULT IN RECOVERY OF ANY SIGNIFICANT SOIL OR ROCK MATERIAL.
<b>SPT</b>		STANDARD PENETRATION TEST: SAMPLER IS A 1.4 INCH INSIDE DIAMETER SPLIT BARREL, DRIVEN 18 INCHES WITH THE SPT HAMMER. (DISTURBED)
<b>SH</b>		SHELBY TUBE: TAKEN WITH A THIN WALL SAMPLE TUBE, PUSHED INTO THE SOIL AND THEN EXTRACTED. (UNDISTURBED)
<b>VANE</b>		VANE SHEAR TEST: SOIL STRENGTH OBTAINED USING A 4 BLADED SHEAR DEVICE. TYPICALLY USED IN SOFT CLAYS-NO SAMPLE RECOVERED.

## COLUMN DESCRIPTIONS

### **DEPTH:**

Distance in feet below the ground surface.

### **SAMPLE:**

Sample Type as depicted above.

### **BLOW COUNT:**

Number of blows required to advance the sampler 12 inches using a 140 lb hammer with a 30-inch drop. 50/3" indicates penetration refusal (>50 blows) at 3 inches. WH indicates that the weight of the hammer was sufficient to push the sampler 6 inches or more.

### **POCKET PEN.:**

Approximate shear strength of a cohesive soil sample as measured by pocket penetrometer.

### **GRAPHIC LOG:**

Graphic Soil Symbol as depicted on the following page.

### **DRY DENSITY:**

Dry density of an undisturbed or relatively undisturbed sample in lbs/ft<sup>3</sup>.

### **MOISTURE CONTENT:**

Moisture content of a soil sample, expressed as a percentage of the dry weight.

### **LIQUID LIMIT:**

The moisture content above which a soil behaves as a liquid.

### **PLASTIC LIMIT:**

The moisture content above which a soil behaves as a plastic.

### **PASSING #200 SIEVE:**

The percentage of the sample finer than the #200 standard sieve.

### **UNCONFINED SHEAR:**

The shear strength of a cohesive soil sample, as measured in the unconfined state.

# SOIL CLASSIFICATION CHART

MAJOR DIVISIONS			SYMBOLS		TYPICAL DESCRIPTIONS	
			GRAPH	LETTER		
<p><b>COARSE GRAINED SOILS</b></p> <p>MORE THAN 50% OF MATERIAL IS LARGER THAN NO. 200 SIEVE SIZE</p>	<p><b>GRAVEL AND GRAVELLY SOILS</b></p>	<p>CLEAN GRAVELS</p> <p>(LITTLE OR NO FINES)</p>		<b>GW</b>	WELL-GRADED GRAVELS, GRAVEL - SAND MIXTURES, LITTLE OR NO FINES	
		<p>MORE THAN 50% OF COARSE FRACTION RETAINED ON NO. 4 SIEVE</p>	<p>GRAVELS WITH FINES</p> <p>(APPRECIABLE AMOUNT OF FINES)</p>		<b>GP</b>	POORLY-GRADED GRAVELS, GRAVEL - SAND MIXTURES, LITTLE OR NO FINES
			<p>GRAVELS WITH FINES</p> <p>(APPRECIABLE AMOUNT OF FINES)</p>		<b>GM</b>	SILTY GRAVELS, GRAVEL - SAND - SILT MIXTURES
	<p><b>SAND AND SANDY SOILS</b></p>	<p>CLEAN SANDS</p> <p>(LITTLE OR NO FINES)</p>		<b>SW</b>	WELL-GRADED SANDS, GRAVELLY SANDS, LITTLE OR NO FINES	
				<b>SP</b>	POORLY-GRADED SANDS, GRAVELLY SAND, LITTLE OR NO FINES	
		<p>MORE THAN 50% OF COARSE FRACTION PASSING ON NO. 4 SIEVE</p>	<p>SANDS WITH FINES</p> <p>(APPRECIABLE AMOUNT OF FINES)</p>		<b>SM</b>	SILTY SANDS, SAND - SILT MIXTURES
			<p>SANDS WITH FINES</p> <p>(APPRECIABLE AMOUNT OF FINES)</p>		<b>SC</b>	CLAYEY SANDS, SAND - CLAY MIXTURES
	<p><b>FINE GRAINED SOILS</b></p> <p>MORE THAN 50% OF MATERIAL IS SMALLER THAN NO. 200 SIEVE SIZE</p>	<p><b>SILTS AND CLAYS</b></p> <p>LIQUID LIMIT LESS THAN 50</p>		<b>ML</b>	INORGANIC SILTS AND VERY FINE SANDS, ROCK FLOUR, SILTY OR CLAYEY FINE SANDS OR CLAYEY SILTS WITH SLIGHT PLASTICITY	
				<b>CL</b>	INORGANIC CLAYS OF LOW TO MEDIUM PLASTICITY, GRAVELLY CLAYS, SANDY CLAYS, SILTY CLAYS, LEAN CLAYS	
				<b>OL</b>	ORGANIC SILTS AND ORGANIC SILTY CLAYS OF LOW PLASTICITY	
<p><b>SILTS AND CLAYS</b></p> <p>LIQUID LIMIT GREATER THAN 50</p>			<b>MH</b>	INORGANIC SILTS, MICACEOUS OR DIATOMACEOUS FINE SAND OR SILTY SOILS		
			<b>CH</b>	INORGANIC CLAYS OF HIGH PLASTICITY		
			<b>OH</b>	ORGANIC CLAYS OF MEDIUM TO HIGH PLASTICITY, ORGANIC SILTS		
<p><b>HIGHLY ORGANIC SOILS</b></p>				<b>PT</b>	PEAT, HUMUS, SWAMP SOILS WITH HIGH ORGANIC CONTENTS	

NOTE: DUAL SYMBOLS ARE USED TO INDICATE BORDERLINE SOIL CLASSIFICATIONS



JOB NO.: 21G190-2	EXCAVATION DATE: 7/16/21	WATER DEPTH: ---
PROJECT: Proposed Warehouse	EXCAVATION METHOD: Backhoe	CAVE DEPTH: ---
LOCATION: San Bernardino, California	LOGGED BY: Jose Zuniga	READING TAKEN: At Completion

FIELD RESULTS					LABORATORY RESULTS							COMMENTS
DEPTH (FEET)	SAMPLE	BLOW COUNT	POCKET PEN. (TSF)	GRAPHIC LOG	DESCRIPTION	DRY DENSITY (PCF)	MOISTURE CONTENT (%)	LIQUID LIMIT	PLASTIC LIMIT	PASSING #200 SIEVE (%)	ORGANIC CONTENT (%)	
SURFACE ELEVATION: --- MSL												
					<u>FILL</u> : Brown Silty fine Sand, abundant fine root fibers, loose-very moist							
					Light Brown fine to medium Sand, trace fine to coarse Gravel, porous, little Iron oxide staining, medium dense-very moist		18					
5					Light Brown fine to medium Sand, trace fine to coarse Gravel, porous, abundant Iron oxide staining, loose-very moist		23					
					<u>ALLUVIUM</u> : Light Brown fine to medium Sand, trace fine to coarse Gravel, porous, abundant Iron oxide staining, loose-very moist							
					Light Brown fine to coarse Sand, little to some fine to coarse Gravel, occasional Cobbles, laminated layering, loose-very moist							
10					Red Brown fine to coarse Sandy Gravel, occasional Cobbles, trace Silt nodules, loose-very moist		16			4		
Trench Terminated at 10'												

TBL\_21G190-2.GPJ\_SOCALGEO.GDT\_8/19/21



JOB NO.: 21G190-2	EXCAVATION DATE: 7/16/21	WATER DEPTH: ---
PROJECT: Proposed Warehouse	EXCAVATION METHOD: Backhoe	CAVE DEPTH: ---
LOCATION: San Bernardino, California	LOGGED BY: Jose Zuniga	READING TAKEN: At Completion

FIELD RESULTS					DESCRIPTION	LABORATORY RESULTS						COMMENTS
DEPTH (FEET)	SAMPLE	BLOW COUNT	POCKET PEN. (TSF)	GRAPHIC LOG		DRY DENSITY (PCF)	MOISTURE CONTENT (%)	LIQUID LIMIT	PLASTIC LIMIT	PASSING #200 SIEVE (%)	ORGANIC CONTENT (%)	
SURFACE ELEVATION: --- MSL												
5	[Hand icon]			[Graphic Log Pattern]	<u>FILL</u> : Brown Silty fine to medium Sand, abundant fine root fibers, loose-very moist							
					Light Brown fine to medium Sand, medium dense-very moist							
					Light Brown fine to coarse Sand, occasional Cobbles, abundant Iron oxide staining, micaceous, loose-very moist							
					<u>ALLUVIUM</u> : Light Brown Gravelly fine to coarse Sand, occasional Cobbles, loose-very moist							
10	[Hand icon]			[Graphic Log Pattern]	Brown to Red Brown Gravelly fine to coarse Sand, occasional Cobbles, abundant Iron oxide staining, loose-very moist							
					Trench Terminated at 10'							

TBL 21G190-2.GPJ\_SOCALGEO.GDT 8/19/21

## INFILTRATION CALCULATIONS

Project Name	Proposed Warehouse
Project Location	San Bernardino, California
Project Number	21G190-2
Engineer	Jose Zuniga

Infiltration Test No I-1

Constants			
	Diameter (ft)	Area (ft <sup>2</sup> )	Area (cm <sup>2</sup> )
Inner	1	0.79	730
Anlr. Spac	2	2.36	2189

\*Note: The infiltration rate was calculated based on current time interval

Test Interval		Time (hr)	Interval Elapsed (min)	Flow Readings				Infiltration Rates			
				Inner Ring (ml)	Ring Flow (cm <sup>3</sup> )	Annular Ring (ml)	Space Flow (cm <sup>3</sup> )	Inner Ring* (cm/hr)	Annular Space* (cm/hr)	Inner Ring* (in/hr)	Annular Space* (in/hr)
1	Initial	9:00 AM	3	0		0					
	Final	9:03 AM	<b>3</b>	2700	2700	11000	11000	74.01	100.51	29.14	39.57
2	Initial	9:05 AM	3	0		0					
	Final	9:08 AM	<b>8</b>	2650	2650	10900	10900	72.64	99.59	28.60	39.21
3	Initial	9:10 AM	3	0		0					
	Final	9:13 AM	<b>13</b>	2600	2600	10800	10800	71.27	98.68	28.06	38.85
4	Initial	9:15 AM	3	0		0					
	Final	9:18 AM	<b>18</b>	2500	2500	10800	10800	68.53	98.68	26.98	38.85
5	Initial	9:20 AM	3	0		0					
	Final	9:23 AM	<b>23</b>	2500	2500	10700	10700	68.53	97.77	26.98	38.49
6	Initial	9:25 AM	3	0		0					
	Final	9:28 AM	<b>28</b>	2500	2500	10700	10700	68.53	97.77	26.98	38.49
7	Initial	9:30 AM	3	0		0					
	Final	9:33 AM	<b>33</b>	2300	2300	10600	10600	63.05	96.85	24.82	38.13
8	Initial	9:35 AM	3	0		0					
	Final	9:38 AM	<b>38</b>	2300	2300	10600	10600	63.05	96.85	24.82	38.13
9	Initial	9:40 AM	3	0		0					
	Final	9:43 AM	<b>43</b>	2200	2200	10500	10500	60.30	95.94	23.74	37.77
10	Initial	9:45 AM	3	0		0					
	Final	9:48 AM	<b>48</b>	2100	2100	10400	10400	57.56	95.02	22.66	37.41
11	Initial	9:50 AM	3	0		0					
	Final	9:53 AM	<b>53</b>	2000	2000	10400	10400	54.82	95.02	21.58	37.41
12	Initial	9:55 AM	3	0		0					
	Final	9:58 AM	<b>58</b>	2000	2000	10300	10300	54.82	94.11	21.58	37.05
13	Initial	10:00 AM	3	0		0					
	Final	10:03 AM	<b>63</b>	2000	2000	10300	10300	54.82	94.11	21.58	37.05
14	Initial	10:05 AM	3	0		0					
	Final	10:08 AM	<b>68</b>	1900	1900	10300	10300	52.08	94.11	20.50	37.05
15	Initial	10:10 AM	3	0		0					
	Final	10:13 AM	<b>73</b>	1900	1900	10200	10200	52.08	93.20	20.50	36.69

16	Initial	10:15 AM	3	0	1850	0	10100	50.71	92.28	19.96	36.33
	Final	10:18 AM	<b>78</b>	1850		10100					
17	Initial	10:20 AM	3	0	1850	0	10100	50.71	92.28	19.96	36.33
	Final	10:23 AM	<b>83</b>	1850		10100					
18	Initial	10:25 AM	3	0	1800	0	10000	49.34	91.37	19.43	35.97
	Final	10:28 AM	<b>88</b>	1800		10000					
19	Initial	10:30 AM	3	0	1800	0	10000	49.34	91.37	19.43	35.97
	Final	10:33 AM	<b>93</b>	1800		10000					
20	Initial	10:35 AM	3	0	1800	0	10000	49.34	91.37	19.43	35.97
	Final	10:38 AM	<b>98</b>	1800		10000					



**INFILTRATION CALCULATIONS**

Project Name	Proposed Warehouse
Project Location	San Bernardino, California
Project Number	21G190-2
Engineer	Jose Zuniga

Infiltration Test No I-2

Constants			
	Diameter (ft)	Area (ft <sup>2</sup> )	Area (cm <sup>2</sup> )
Inner	1	0.79	730
Anlr. Spac	2	2.36	2189

\*Note: The infiltration rate was calculated based on current time interval

Test Interval		Time (hr)	Interval Elapsed (min)	Flow Readings				Infiltration Rates			
				Inner Ring (ml)	Ring Flow (cm <sup>3</sup> )	Annular Ring (ml)	Space Flow (cm <sup>3</sup> )	Inner Ring* (cm/hr)	Annular Space* (cm/hr)	Inner Ring* (in/hr)	Annular Space* (in/hr)
1	Initial	11:00 AM	3	0		0					
	Final	11:03 AM	<b>3</b>	3200	3200	11000	11000	87.72	100.51	34.53	39.57
2	Initial	11:05 AM	3	0		0					
	Final	11:08 AM	<b>8</b>	3100	3100	10900	10900	84.97	99.59	33.45	39.21
3	Initial	11:10 AM	3	0		0					
	Final	11:13 AM	<b>13</b>	3000	3000	10800	10800	82.23	98.68	32.38	38.85
4	Initial	11:15 AM	3	0		0					
	Final	11:18 AM	<b>18</b>	3000	3000	10800	10800	82.23	98.68	32.38	38.85
5	Initial	11:20 AM	3	0		0					
	Final	11:23 AM	<b>23</b>	2900	2900	10700	10700	79.49	97.77	31.30	38.49
6	Initial	11:25 AM	3	0		0					
	Final	11:28 AM	<b>28</b>	2800	2800	10700	10700	76.75	97.77	30.22	38.49
7	Initial	11:30 AM	3	0		0					
	Final	11:33 AM	<b>33</b>	2700	2700	10600	10600	74.01	96.85	29.14	38.13
8	Initial	11:35 AM	3	0		0					
	Final	11:38 AM	<b>38</b>	2600	2600	10600	10600	71.27	96.85	28.06	38.13
9	Initial	11:40 AM	3	0		0					
	Final	11:43 AM	<b>43</b>	2500	2500	10500	10500	68.53	95.94	26.98	37.77
10	Initial	11:45 AM	3	0		0					
	Final	11:48 AM	<b>48</b>	2400	2400	10400	10400	65.79	95.02	25.90	37.41
11	Initial	11:50 AM	3	0		0					
	Final	11:53 AM	<b>53</b>	2300	2300	10400	10400	63.05	95.02	24.82	37.41
12	Initial	11:55 AM	3	0		0					
	Final	11:58 AM	<b>58</b>	2200	2200	10400	10400	60.30	95.02	23.74	37.41
13	Initial	12:00 PM	3	0		0					
	Final	12:03 PM	<b>63</b>	2100	2100	10300	10300	57.56	94.11	22.66	37.05
14	Initial	12:05 PM	3	0		0					
	Final	12:08 PM	<b>68</b>	2000	2000	10300	10300	54.82	94.11	21.58	37.05
15	Initial	12:10 PM	3	0		0					
	Final	12:13 PM	<b>73</b>	1900	1900	10200	10200	52.08	93.20	20.50	36.69

16	Initial	12:15 PM	3	0	1900	0	10200	52.08	93.20	20.50	36.69
	Final	12:18 PM	<b>78</b>	1900		10200					
17	Initial	12:20 PM	3	0	1850	0	10200	50.71	93.20	19.96	36.69
	Final	12:23 PM	<b>83</b>	1850		10200					
18	Initial	12:25 PM	3	0	1850	0	10100	50.71	92.28	19.96	36.33
	Final	12:28 PM	<b>88</b>	1850		10100					
19	Initial	12:30 PM	3	0	1850	0	10100	50.71	92.28	19.96	36.33
	Final	12:33 PM	<b>93</b>	1850		10100					
20	Initial	12:35 PM	3	0	1850	0	10100	50.71	92.28	19.96	36.33
	Final	12:38 PM	<b>98</b>	1850		10100					

# Grain Size Distribution

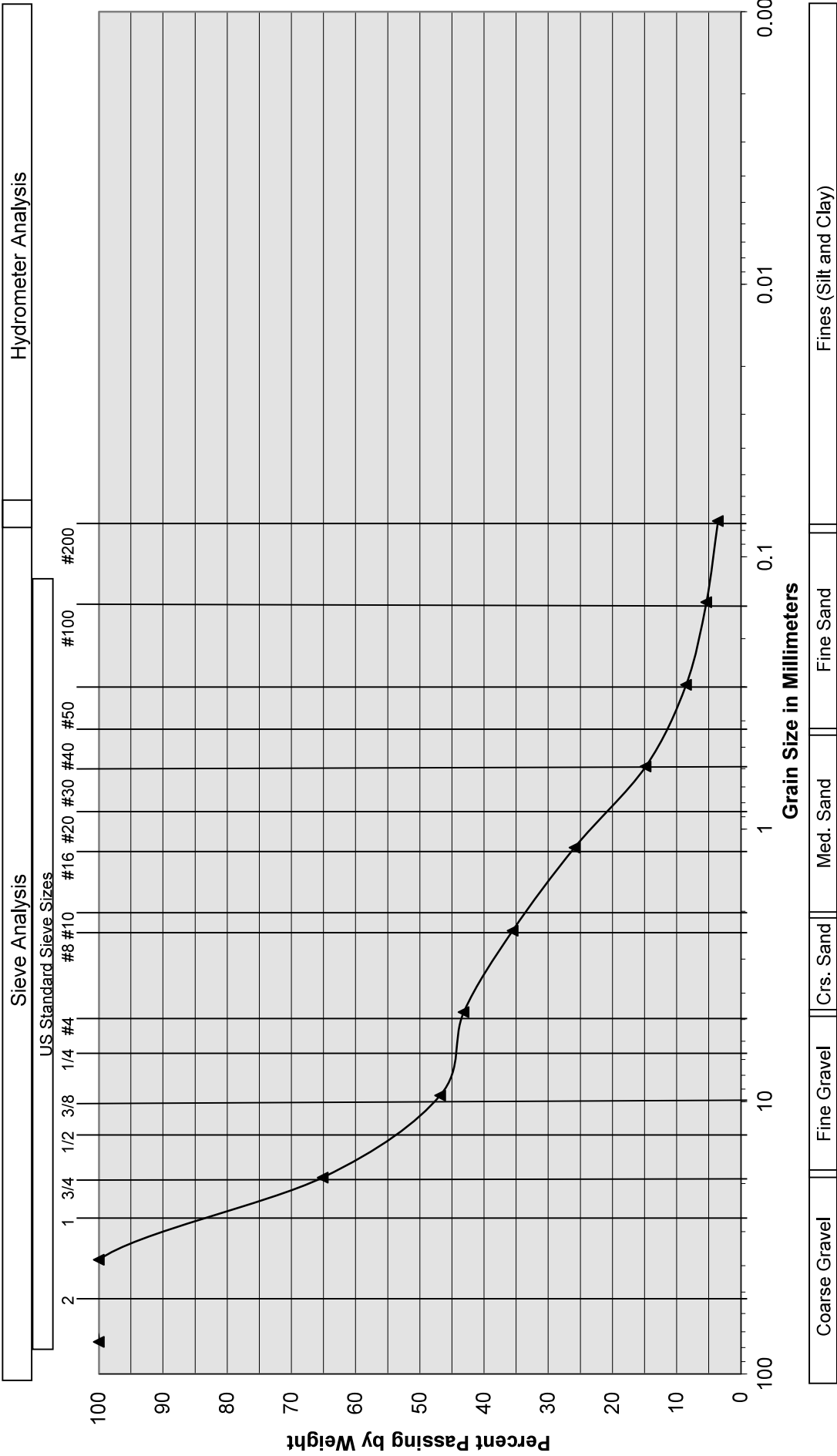

Sample Description: I-1 @ 9 feet  
 Soil Classification: Red Brown fine to coarse Sandy Gravel, occasional Cobbles, trace Silt  
 Proposed Warehouse  
 San Bernardino, CA  
 Project No. 21G190-2  
**PLATE C-1**



A California Corporation

# Grain Size Distribution

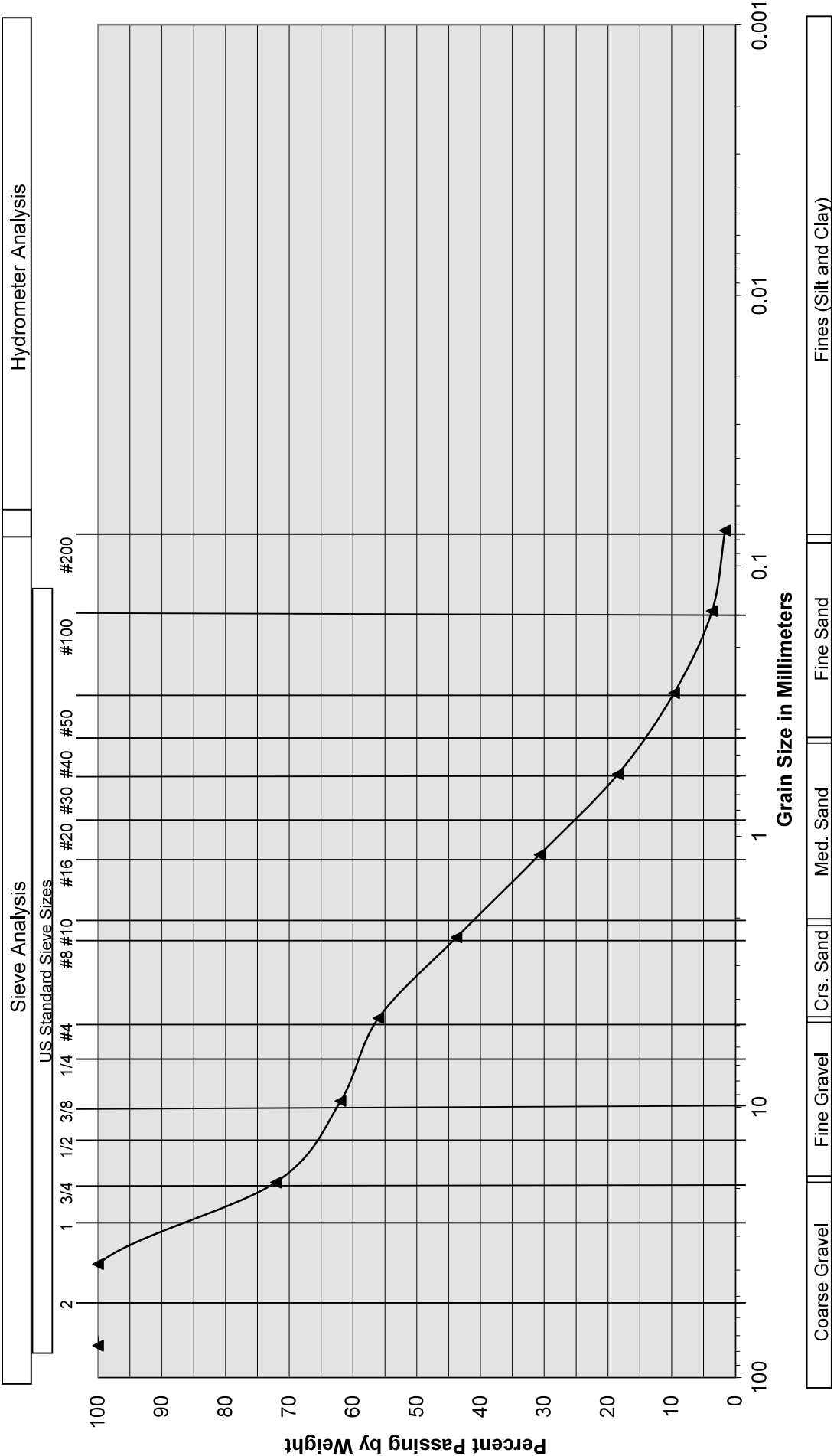

Sample Description: I-2 @ 9 feet  
 Soil Classification: Brown to Red Brown Gravelly fine to coarse Sand, occasional Cobbles

Proposed Warehouse  
 San Bernardino, CA  
 Project No. 21G190-2  
**PLATE C-2**



VII.4.1. Site Suitability Considerations

Suitability assessment related considerations include ([Table VII.3](#)):

- Soil assessment methods – the site assessment extent (e.g., number of borings, test pits, etc.) and the measurement method used to estimate the short-term infiltration rate.
- Predominant soil texture/percent fines – soil texture and the percent of fines can greatly influence the potential for clogging.
- Site soil variability – site with spatially heterogeneous soils (vertically or horizontally) as determined from site investigations are more difficult to estimate average properties for resulting in a higher level of uncertainty associated with initial estimates.
- Depth to seasonal high groundwater/impervious layer – groundwater mounding may become an issue during excessively wet conditions where shallow aquifers or shallow clay lenses are present.

**Table VII.3: Suitability Assessment Related Considerations for Infiltration Facility Safety Factors**

Consideration	High Concern	Medium Concern	Low Concern
Assessment methods (see explanation below)	Use of soil survey maps or simple texture analysis to estimate short-term infiltration rates	Direct measurement of $\geq 20$ percent of infiltration area with localized infiltration measurement methods (e.g., infiltrometer)	Direct measurement of $\geq 50$ percent of infiltration area with localized infiltration measurement methods or Use of extensive test pit infiltration measurement methods
Texture Class	Silty and clayey soils with significant fines	Loamy soils	Granular to slightly loamy soils
Site soil variability	Highly variable soils indicated from site assessment or limited soil borings collected during site assessment	Soil borings/test pits indicate moderately homogeneous soils	Multiple soil borings/test pits indicate relatively homogeneous soils
Depth to groundwater/ impervious layer	<5 ft below facility bottom	5-10 ft below facility bottom	>10 below facility bottom

Per infiltration report in Attachment D

Per infiltration report in Attachment D

Per infiltration report in Attachment D

Per infiltration report in Attachment D

Localized infiltration testing refers to methods such as the double ring infiltrometer test (ASTM D3385-88) which measure infiltration rates over an area less than 10 sq-ft, may include lateral

flow, and do not attempt to account for heterogeneity of soil. The amount of area each test represents should be estimated depending on the observed heterogeneity of the soil.

Extensive infiltration testing refers to methods that include excavating a significant portion of the proposed infiltration area, filling the excavation with water, and monitoring drawdown. The excavation should be to the depth of the proposed infiltration surface and ideally be at least 50 to 100 square feet.

In all cases, testing should be conducted in the area of the proposed BMP where, based on review of available geotechnical data, soils appear least likely to support infiltration.

### VII.4.2. Design Related Considerations

Design related considerations include ([Table VII.4](#)):

- Size of area tributary to facility – all things being equal, risk factors related to infiltration facilities increase with an increase in the tributary area served. Therefore facilities serving larger tributary areas should use more restrictive adjustment factors.
- Level of pretreatment/expected influent sediment loads – credit should be given for good pretreatment by allowing less restrictive factors to account for the reduced probability of clogging from high sediment loading. Also, facilities designed to capture runoff from relatively clean surfaces such as rooftops are likely to see low sediment loads and therefore should be allowed to apply less restrictive safety factors.
- Redundancy – facilities that consist of multiple subsystems operating in parallel such that parts of the system remains functional when other parts fail and/or bypass should be rewarded for the built-in redundancy with less restrictive correction and safety factors. For example, if bypass flows would be at least partially treated in another BMP, the risk of discharging untreated runoff in the event of clogging the primary facility is reduced. A bioretention facility that overflows to a landscaped area is another example.
- Compaction during construction – proper construction oversight is needed during construction to ensure that the bottoms of infiltration facility are not overly compacted. Facilities that do not commit to proper construction practices and oversight should have to use more restrictive correction and safety factors.

**Table VII.4: Design Related Considerations for Infiltration Facility Safety Factors**

Consideration	High Concern	Medium Concern	Low Concern
Tributary area size	Greater than 10 acres.	Greater than 2 acres but less than 10 acres.	2 acres or less.
Level of pretreatment/ expected influent sediment loads	Pretreatment from gross solids removal devices only, such as hydrodynamic separators, racks and screens AND tributary area includes landscaped areas, steep slopes, high traffic areas, or any other areas expected to produce high sediment, trash, or debris loads.	Good pretreatment with BMPs that mitigate coarse sediments such as vegetated swales AND influent sediment loads from the tributary area are expected to be relatively low (e.g., low traffic, mild slopes, disconnected impervious areas, etc.).	Excellent pretreatment with BMPs that mitigate fine sediments such as bioretention or media filtration OR sedimentation or facility only treats runoff from relatively clean surfaces, such as rooftops.
Redundancy of treatment	No redundancy in BMP treatment train.	Medium redundancy, other BMPs available in treatment train to maintain at least 50% of function of facility in event of failure.	High redundancy, multiple components capable of operating independently and in parallel, maintaining at least 90% of facility functionality in event of failure.
Compaction during construction	Construction of facility on a compacted site or elevated probability of unintended/ indirect compaction.	Medium probability of unintended/ indirect compaction.	Heavy equipment actively prohibited from infiltration areas during construction and low probability of unintended/ indirect compaction.

14.32 acres

Catch basin filters (Bio-Clean or approved equal) will be provided in all on-site catch basins and CDS Units (Contech or approved equal) will be provided on storm drain main lines as pre-treatment control BMPs prior to allowing runoff to be conveyed to the primary treatment BMP. The pre-treatment devices will help remove large debris, trash, sediment and oil/grease from the runoff before outletting into the the on-site infiltration systems. See Attachment B for catch basin filter specification.

The soil in the proposed infiltration system footprints will be uncompacted in-place native material.

Specific project site pollutants that will be treated by these Bio-Clean Filter Systems are as follows: Fine TSS - 85%, Dissolved Phosphorus - 69%, Copper 95%, Lead - 87%, Zinc - 95%, Oil and Grease - 90-95%, Fecal Coliform (bacteria) - 68%. Bio-Clean filter has multi-level screening and hydrocarbon media captures everything from oil and grease to sediments, to foliage and litter. According to Bio-Clean Stormwater Catch Basin Filtration Device Specification 03.01.02, "The SCBFD will remove and retain debris, sediments, metals, nutrients, oxygen demanding substances, bacteria and hydrocarbons entering the filter during frequent storm events and specified flow rates." See Attachment B for catch basin filter specification.

VII.4.3. Determining Factor of Safety

A factor of safety shall be used. To assist in selecting the appropriate design infiltration rate, the measured short term infiltration rate should be adjusted using a weighted average of several safety factors using the worksheet shown in **Worksheet H** below. The design infiltration rate would be determined as follows:

1. For each consideration shown in **Table VII.3** and **Table VII.4** above, determine whether the consideration is a high, medium, or low concern.
2. For all high concerns, assign a factor value of 3, for medium concerns, assign a factor value of 2, and for low concerns assign a factor value of 1.
3. Multiply each of the factors by the corresponding weight to get a product.
4. Sum the products within each factor category to obtain a safety factor for each.
5. Multiply the two safety factors together to get the final combined safety factor. If the combined safety factor is less than 2, then 2 shall be used as the safety factor.
6. Divide the measured short term infiltration rate by the combined safety factor to obtain the adjusted design infiltration rate for use in sizing the infiltration facility.

The design infiltration rate shall be used to size BMPs and to evaluate their expected long term performance. This rate shall not be less than 2, but may be higher at the discretion of the design engineer.



**Worksheet H: Factor of Safety and Design Infiltration Rate and Worksheet**

Factor Category		Factor Description	Assigned Weight (w)	Factor Value (v)	Product (p) $p = w \times v$
A	Suitability Assessment	Soil assessment methods	0.25	1	0.25
		Predominant soil texture	0.25	1	0.25
		Site soil variability	0.25	1	0.25
		Depth to groundwater / impervious layer	0.25	1	0.25
		Suitability Assessment Safety Factor, $S_A = \Sigma p$			
B	Design	Tributary area size	0.25	3	0.75
		Level of pretreatment/ expected sediment loads	0.25	2	0.50
		Redundancy	0.25	2	0.50
		Compaction during construction	0.25	1	0.25
		Design Safety Factor, $S_B = \Sigma p$			
Combined Safety Factor, $S_{TOT} = S_A \times S_B$				3.00	
Measured Infiltration Rate, inch/hr, $K_M$ (corrected for test-specific bias)				20.00	
Design Infiltration Rate, in/hr, $K_{DESIGN} = S_{TOT} \times K_M$				6.67 in/hr	
<b>Supporting Data</b>					
Briefly describe infiltration test and provide reference to test forms:  <p style="color: blue; text-align: center;">See Infiltration Report in Attachment D. Safety Factor of 3 will be used for BMP Calculations.</p>					

**Note:** The minimum combined adjustment factor shall not be less than 2.0 and the maximum combined adjustment factor shall not exceed 9.0.

**VII.5. References**

ASTM D 3385-94, 2003. "Standard Test Method for Infiltration Rate of Soils Field Using Double-Ring Infiltrometer." American Society for Testing Materials, Conshohocken, PA. 10 Jun, 2003.

Caltrans, 2003. "Infiltration Basin Site Selection". Study Volume I. California Department of Transportation. Report No. CTSW-RT-03-025.

City of Portland, 2010. *Appendix F.2: Infiltration Testing*. Portland Stormwater Management Manual, Revised February 1, 2010.

United States Department of the Interior, Bureau of Reclamation (USBR), 1990a, "Procedure for Performing Field Permeability Testing by the Well Permeameter Method (USBR 7300-89)," in *Earth Manual, Part 2, A Water Resources Technical Publication*, 3rd ed., Bureau of Reclamation, Denver, Colo.

# **Attachment E**

## **Maintenance Agreement & Inspection Guidelines**

## **Site Maintenance Guideline**

### **Landscape and Irrigation Design and Maintenance:**

See CASQA BMP Fact Sheet SD-10 in Attachment C

- Site landscaping design shall be implemented in accordance with the requirements of the site specific WQMP and local agency requirements.
- Site landscaping maintenance shall begin immediately after it has been planted.
- Maintenance of landscaping shall occur on a weekly basis and adjusted accordingly based on current conditions and seasonal needs.
- Inspection of irrigation system shall be provided on a bi-weekly basis to ensure proper function of the irrigation system, no significant overspray is occurring.
- Malfunctioning systems shall be repaired or replaced immediately.
- Inspect plant health on a monthly basis. Repair or replace unhealthy plants as needed.
- Inspect side slopes of basins and sloped areas on a bi-weekly basis and repair as needed. Re-plant and apply erosion protection to those areas to help prevent erosion in the future.
- Landscape clippings shall be swept and picked up immediately to prevent it from entering the storm drain system or adjacent sedimentation basins and filtration basins. Dispose of landscape clippings in a legal manner

### **MS4 Stenciling and Signage:**

See CASQA BMP Fact Sheet SD-13 in Attachment C

- MS4 Stenciling and signage shall be placed during construction and inspection and maintenance shall begin upon completion of construction.
- Inspect catch basin stenciling on a bi-monthly basis. Replace any damaged, missing or faded stencils in a timely manner.

### **Common area litter control, loading docks and trash storage areas:**

See CASQA BMP Fact Sheet SD-32 in Attachment C

- Inspection and Maintenance of common areas, loading docks and trash storage areas shall begin upon completion of construction.
- Visual inspection of common areas and loading docks shall take place on a daily basis and adjusted on an as needed basis. Visual inspection of trash storage areas shall take place on a weekly basis and adjusted on an as needed basis.
- Inspect areas for trash and debris. Remove any found trash and debris immediately. Dispose of trash and debris in a legal manner.
- Inspect areas for any spills. Pick up/clean up found spills immediately. Dispose of spill material in a legal manner.

### **Parking lot sweeping:**

See CASQA BMP Fact Sheet SE-7 in Appendix 10

- Parking lot sweeping shall begin after the completion of construction and take place on a monthly basis.
- Dispose of picked up material in a legal manner.

**Drainage facility (including roof drains) inspection and maintenance:**

- Inspection and maintenance of site drainage facilities and roof drains shall begin immediately upon completion of construction.
- Catch basin and roof drain inspections shall take place on a monthly basis, prior to a rain event and after a rain event.
- Collected debris shall be removed. Catch basins and roof drain inlet shall be clear of any debris prior to any storm event to ensure proper function of the roof drains. Collected debris shall be disposed of in a legal manner.
- Catch basin filters shall be inspected on a monthly basis.
- Catch basin filters that have exceeded 50% of the storage capacity shall be cleaned immediately.
- Catch basin filters shall be maintained per the manufacturer's specifications.
- Damaged catch basin filters shall be replaced with an approved equal prior to the next storm event or as soon as practicable.

**Underground Infiltration/detention Basins**

See Attachment A Project Site WQMP Site Plan

- Infiltration/detention facilities maintenance should include frequent inspections to ensure that water infiltrates into the subsurface completely within the recommended infiltration time of 48 hours or less after a storm.
- Observe and document evidence of collected sediments, trash, debris and oils/greases.
- Sediments, trash, debris and oils/greases shall be removed and disposed of in a legal manner by manufacture Bi-monthly and prior to storm event.
- Observe and document evidence of erosion of side slopes or flowlines.
- Protection measures against further erosion shall be placed until the eroded areas are repaired.

**TO BE PROVIDER IN FINAL WQMP DOCUMENT**

RECORDING REQUESTED BY:

WHEN RECORDED RETURN TO:

City of San Bernardino  
Community Development Department  
3<sup>RD</sup> FLOOR  
201 North "E" Street  
San Bernardino, CA 92401

---

SPACE ABOVE THIS LINE FOR RECORDER'S USE ONLY

**AGREEMENT**

**STORMWATER TREATMENT DEVICE AND CONTROL MEASURE ACCESS  
AND MAINTENANCE AGREEMENT**

**Owner:** \_\_\_\_\_

**Tract No.:** \_\_\_\_\_ **APN:** \_\_\_\_\_

**Address:** \_\_\_\_\_

THIS AGREEMENT is made and entered into this \_\_\_ day of \_\_\_\_, 20\_\_, between the City of San Bernardino, a Charter City and municipal corporation, ("City") and Owner. The Owner and the City are sometimes each individually referred to herein as a "Party" and, collectively, as the "Parties."

**RECITALS**

WHEREAS, the Owner owns real property ("Property") in the City specifically described in Exhibits "A" and "B" which are attached hereto and incorporated herein by this reference; and

WHEREAS, at the time of approval of the Owner's development project commonly known as Southbay Inland Center Industrial (the "Project"), the City required the Project to employ on-site control measures to minimize pollutants in urban stormwater runoff; and

WHEREAS, the Owner has chosen to install underground infiltration basin and catch basin filters [e.g. vegetated swales, drain inserts, media filters, pervious building material and other control measures] (the "Devices") to minimize pollutants in urban stormwater runoff; and

WHEREAS, the Devices having been installed in accordance with plans and specifications approved by the City; and

WHEREAS, the Devices being installed on private property and draining only private property, are private facilities with all maintenance or replacement therefore being the sole responsibility of the Owner; and

WHEREAS, the Owner is aware that periodic and continuous maintenance including, but not necessarily limited to, filter material replacement and sediment removal as specified in the site's Water Quality Management Plan (WQMP) is required to assure proper performance of the Devices; and

WHEREAS, the Owner is also aware that such maintenance activity will require compliance with all Federal, State and local laws and regulations, including those pertaining to confined space and waste disposal methods in effect at the time such maintenance occurs; and

WHEREAS, California Regional Water Quality Control Board Order No. R8-2010-0036 (NPDES No. CAS 618036) San Bernardino County Municipal Separate Storm Sewer System (MS4) Permit and San Bernardino Municipal Code Section 8.80.208 requires this Stormwater Treatment Device and Control Measure Access and Maintenance Agreement;

NOW, THEREFORE, in consideration of the City's approval of the Project and the mutual promises contained herein, the City of San Bernardino and Owner agree as follows:

### AGREEMENT

1. The Owner hereby provides the City and its designees with full right of access to the Devices and the Owner's Property in the immediate vicinity of the Devices (a) at any time, upon reasonable notice; or (b) in the event of emergency, as determined by City's Community Development Director with no advance notice; for the purpose of inspecting, sampling and testing of the Devices, and in cases of emergency, to undertake all necessary repairs or other preventative measures at the Owner's expense as provided for in Section 3, below. The City shall make every effort at all times to minimize or avoid interference with the Owner's use of the Property when undertaking such inspections and repairs.
2. The Owner shall diligently maintain the Devices in a manner consistent with the manufacturers' recommended maintenance schedule or the maintenance schedule supplied in the site's WQMP to ensure efficient performance. All reasonable precautions shall be exercised by the Owner and the Owner's representatives in the removal and extraction of materials from the Devices, and the ultimate disposal of the materials in a manner consistent with all applicable laws. As may be requested from time to time by the City, the Owner shall provide the City with documentation identifying the materials removed, the quantity and the location of disposal destinations, as appropriate.
3. In the event the Owner fails to perform the necessary maintenance required by this Agreement within thirty (30) days of being given written notice by the City to do so, setting forth with specificity the action to be taken, the City is authorized to cause any maintenance necessary to be done and charge the entire cost and expense to the Owner, including administrative costs, attorneys' fees and interest thereon at the maximum rate authorized by law. Owner agrees that City may record a lien against the Property twenty (20) days after the City sends Owner the notice of charges if said charges have not been paid in full by Owner.
4. This Agreement shall be recorded in the Official Records of the County of San Bernardino at the expense of the Owner and shall constitute notice to all successors and assigns to the title to the Property of the obligations herein set forth.
5. In the event any action is commenced to enforce or interpret any of the terms or conditions of this Agreement the prevailing Party shall, in addition to any costs and other relief, be entitled to

the recovery of its reasonable attorneys' fees. The costs, salary and expenses of the City Attorney and members of his office in enforcing this Agreement on behalf of the City shall be considered "attorney's fees" for the purposes of this Agreement.

6. It is the intent of the Parties that the burdens and benefits herein undertaken shall constitute equitable servitudes that run with the Property and shall be binding upon future owners of all or any portion of the Property. Any owner's liability hereunder shall terminate at the time it ceases to be an owner of the encumbered Property, except for obligations which accrue prior to the date of transfer by such owner, which shall remain the personal obligation of such owner.
7. Time is of the essence in the performance of this Agreement.
8. Any notice to a Party required or called for in this Agreement shall be served in person, or by deposit in the U.S. Mail, first class postage prepaid, to the address set forth below. Notice(s) shall be deemed effective upon receipt, or seventy-two (72) hours after deposit in the U.S. Mail, whichever is earlier. A Party may change notice address only by providing written notice thereof to the other Party.

CITY

OWNER

Community Development Director  
City of San Bernardino  
201, North "E" Street  
San Bernardino, CA 92401

9. This Agreement shall be governed by and construed in accordance with the laws of the State of California.



STORMWATER TREATMENT DEVICE AND CONTROL MEASURE ACCESS  
AND MAINTENANCE AGREEMENT

10. Any amendment to this Agreement shall be in writing and approved by the Community Development Director of the City and signed by the City and the Owner.

I, THE UNDERSIGNED, HAVE A SUFFICIENT OWNERSHIP INTEREST IN THE PROPERTY HEREIN TO CONSENT TO THE IMPOSITION OF A LIEN THEREON, AND HAVE READ AND UNDERSTAND THE FOREGOING AND, BY MY SIGNATURE, AGREE TO COMPLY IN ALL RESPECTS WITH THE CONDITIONS OF THIS AGREEMENT AND ***DO HEREBY PERSONALLY GUARANTEE*** THE PAYMENT OF THESE FEES AND FURTHER AGREE TO THE PLACEMENT OF A LIEN AS DESCRIBED ABOVE ON THE PROPERTY.

Name of Company \_\_\_\_\_

Signature \_\_\_\_\_

Name \_\_\_\_\_ Title \_\_\_\_\_

(please print)

Mailing address \_\_\_\_\_

City \_\_\_\_\_ State \_\_\_\_\_ Zip \_\_\_\_\_

Phone \_\_\_\_\_

APPROVED AS TO CONTENT:

By: \_\_\_\_\_

Mark Persico, Director  
Community Development Department  
City of San Bernardino

NOTE: All Signatures Must be Acknowledged by a Notary Public.